

The threading specialists



GOLIATH
international tools Ltd

PRODUCT CATALOGUE

Quality

Expertise

Service

Flexibility

The UK's
leading manufacturer
of quality taps & dies

Designed &
Manufactured
In ENGLAND

Blue Rapier

SPIRAL FLUTE TAPS *for blind hole tapping*



Ideally suitable for blind hole tapping in most materials, particularly aluminium, brass, copper and similar metals. The build up of swarf at the bottom of the hole is avoided, allowing the tap to maintain full thread depth. SP/Flute taps can be supplied with steam tempered finish, at no extra cost.

Manufactured in high speed steel with ground threads and available in all sizes and thread forms.

Blue Sabre

SPIRAL POINT TAPS *for through hole tapping*

Highly recommended for through hole machine tapping. The angled cutting face forcing the swarf ahead of the tap.

This method reduces tap breakage and reversal is made easier.

Blue Sabre taps are manufactured in high speed steel ground thread which are surface treated to ensure improved production rates.

Both the Blue Sabre and Standard Bright Spiral Points are available in all sizes and thread forms.



FLUTELESS TAPS *for stronger threads*



Threads produced by Fluteless taps are formed and not cut. This method gives greater strength and high tapping speeds. Excellent results can be achieved when threading ductile materials.

Manufactured from high speed steel with ground threads.

Fluteless taps can also be supplied in a flash chromed treatment to give greater resistance to wear.



ALL PRODUCTS ARE
MANUFACTURED IN THE UK





GOLIATH
international tools ltd

COMPANY PROFILE

The Goliath Group of Companies have been established for over 40 years and is one of Europe's leading manufacturers of quality HSS Taps and Dies.

Goliath's large manufacturing facility, Central Warehouse and Headquarters for the group is situated at Goliath House, Newtown Row, Birmingham, England.

From our headquarters in Birmingham, Goliath has established a Network of Companies and agents throughout the world. All Goliath companies have warehouses stocking the full range of products, which enables Goliath to offer a fast and efficient service to our customers.

Goliath is a company committed to improving quality and service on a continuous basis both in manufacturing and distribution.

Our objectives are to offer excellent service with a quality product at a competitive price.



CIRCULAR SPLIT DIES

	PAGE
METRIC COARSE BS1127-1950	33
METRIC COARSE - LEFT HAND BS1127-1950	33
METRIC FINE BS1127-1950	34
UNC BS1127-1950	34
UNC - LEFT HAND BS1127-1950	34
UNF BS1127-1950	35
UNF - LEFT HAND BS1127-1950	35
BSW BS1127-1950	36
BSW - LEFT HAND BS1127-1950	36
BSF BS1127-1950	37
BSF - LEFT HAND BS1127-1950	37
BA BS1127-1950	37
BA - LEFT HAND BS1127-1950	37
NPT BS1127-1950	37
BSB (British Standard Brass) BS1127-1950	38
BSPF BS1127-1950	38
BSPT BS1127-1950	38

HEXAGON DIE NUTS

METRIC COARSE BS1127-1950	39
METRIC FINE BS1127-1950	39
UNC BS1127-1950	40
UNF BS1127-1950	39
BSW BS1127-1950	40
BSF BS1127-1950	40
BA BS1127-1950	40
BSPF BS1127-1950	40

TAP WRENCHES & DIE STOCK

ADJUSTABLE TAP WRENCHES	41
TEE BAR WRENCHES	41
Ratchet Type	
Fixed Type	
DIE STOCKS	41

CASED SETS

THREADING TOOL KITS	42
TAP INDEX SETS	42
TAP & DRILL SETS	42
TAP & DIE SETS	43
HANDY SIX - Six HSS Taps	43
HANDY SIX - Six HSS Circular Dies or Dienuts	43
HANDY SEVEN - Seven HSS Taps	43

TECHNICAL INFORMATION

OTHER PRODUCTS FROM GOLIATH	44
UPDATES	45

TECHNICAL INFORMATION

MAIN TYPES OF TAPS	
Hand Taps	46
Machine Taps	46
Pipe Taps	47
Fluteless Taps	47
SURFACE TREATMENT	48
Nitriding	
Steam Tempering - Blue Finish	
Titanium Nitride Coating (TIN) - Gold Finish	
TAP NOMENCLATURE	49
DIE NOMENCLATURE	49
BASIC PROFILES	50
For ISO Inch (Unified) and ISO Metric	
For Whitworth (BSW, BSF, BSPF)	
Thread Forms	
The Whitworth Screw Thread Tolerance System	
THREAD SYSTEMS	51
TOLERANCE CLASSES OF METRIC TAPS	51
CLASS AND TOLERANCE TABLES	
BSW	52
BSF	52
METRIC (ISO)	52
UNF	53
UNC	53
COMMON THREAD FORMS	54
CUTTING SPEEDS & LUBRICANTS	55
FAULTS & CAUSES	55
STYLE DIAGRAMS	56
Styles 1-10	

Goliath International Tools Ltd.

Newtown Row, Aston, Birmingham, B6 4NQ

Tel: 0121 333 3441 Fax: 0121 359 6647

E. Mail: sales@goliathinternational.com

©2004 Goliath International Tools Ltd.

Designed & Published by S J Productions Ltd.

Tel: 0121 200 2326

Catalogue User Guide

Goliath International Tools has reformatted its new catalogue in order to make it easier to follow for customers and users of Goliath products alike.

All sections are colour coded to make it easier to find the thread section required. Each product section then has a number of symbols to help identify its specific properties and a table reference number so you can refer to a more complete set of dimensions.

Each tap is manufactured to one or more styles, and these are noted below the size and flute information in each product section. The style diagrams can be found on page 56, which is the first page inside the back cover.

Metric Coarse

ISO 529



METRIC

Nominal Major Diameter <i>d</i>	Pitch	Overall Length <i>L</i> mm	Length of Thread <i>l</i> mm	Shank Diameter <i>d</i> 1mm	Neck Diameter <i>d</i> 2mm	Neck Length <i>l</i> 1mm	Square A/F mm	Square Length <i>l</i> 2mm
M1.6	0.35	41	8	2.50	-	5	2.00	4
M2	0.40	41	8	2.50	-	5	2.00	4
M2.2	0.45	44.5	9.5	2.80	-	6	2.24	5
M2.5	0.45	44.5	9.5	2.80	-	6	2.24	5
M2.6	0.45	44.5	9.5	2.80	-	6	2.24	5
M3	0.50	48	11	3.15	2.12	7	2.50	5
M3.5	0.60	50	13	3.55	2.50	8	2.80	5
M4	0.70	53	13	4.00	2.80	8	3.15	6
M4.5	0.75	53	13	4.50	3.15	8	3.55	6
M5	0.80	58	16	5.00	3.55	9	4.00	7
M6	1.00	66	19	6.30	4.50	11	5.00	8
M7	1.00	66	19	7.10	5.30	11	5.60	8
M8	1.25	72	22	8.00	6.00	13	6.30	9
M9	1.25	72	22	9.00	7.10	14	7.10	10
M10	1.50	80	24	10.00	7.50	15	8.00	11
M11	1.50	85	25	8.00	-	-	6.30	9
M12	1.75	89	29	9.00	-	-	7.10	10
M14	2.00	95	30	11.20	-	-	9.00	12
M16	2.00	102	32	12.50	-	-	10.00	13
M18	2.50	112	37	14.00	-	-	11.20	14
M20	2.50	112	37	14.00	-	-	11.20	14
M22	2.50	118	38	16.00	-	-	12.50	16
M24	3.00	130	45	18.00	-	-	14.00	18
M27	3.00	135	45	20.00	-	-	16.00	20
M30	3.50	138	48	20.00	-	-	16.00	20
M33	3.50	151	51	22.40	-	-	18.00	22
M36	4.00	162	57	25.00	-	-	20.00	24
M39	4.00	170	60	28.00	-	-	22.40	26
M42	4.50	170	60	28.00	-	-	22.40	26
M45	4.50	187	67	31.50	-	-	25.00	28
M48	5.00	187	67	31.50	-	-	25.00	28
M52	5.00	200	70	35.50	-	-	28.00	31
M56	5.50	200	70	35.50	-	-	28.00	31

Table Reference Number
 Metric/Imperial
 Pitch Diameter Tolerance
 Class of Fit
 TSB
 Available in:
 Taper Lead
 Second Lead
 Bottom Lead

Straight Flute (Coarse)



	M1.6	M2	M2.2	M2.5	M2.6	M3	M3.5	M4	M4.5	M5	M6	M7	M8	M9
No. of Flutes	3	3	3	3	3	3	3	3	3	3	3	4	4	4
Style	1	1	1	1	1	2	2	2	2	2	2	2	2	2

	M10	M11	M12	M14	M16	M18	M20	M22	M24	M27	M30	M33	M36	M39
No. of Flutes	4	4	4	4	4	4	4	4	4	4	4	4	4	6
Style	2	3	3	3	3	3	3	3	3	3	3	3	3	3

	M42	M45	M48	M52	M56
No. of Flutes	6	6	6	6	6
Style	3	3	3	3	3

Straight Flute - Left Hand (Coarse)



	M3	M4	M5	M6	M8	M10	M12	M14	M16	M18	M20	M24
No. of Flutes	3	3	3	3	4	4	4	4	4	4	4	4
Style	2	2	2	2	2	2	3	3	3	3	3	3

Spiral Point (Coarse)



	M2	M2.5	M3	M3.5	M4	M4.5	M5	M6	M7	M8	M10	M12	M14
No. of Flutes	2	2	2 or 3	2 or 3	2 or 3	2 or 3	2 or 3	2 or 3	3	3	3	3	3
Style	1	1	2	2	2	2	2	2	2	2	2	3	3

	M16	M18	M20	M22	M24	M27	M30
No. of Flutes	3	3	3	3	3	3	3
Style	3	3	3	3	3	3	3

Spiral Flute (Coarse)



	M3	M3.5	M4	M5	M6	M8	M10	M12	M14	M16	M18	M20	M22	M24
No. of Flutes	2	2	2	3	3	3	3	3	3	3	3	3	3	3
Style	2	2	2	2	2	2	2	3	3	3	3	3	3	3

	M27	M30
No. of Flutes	3	3
Style	3	3

Fluteless (Coarse)



	M2	M2.5	M3	M3.5	M4	M5	M6	M8	M10	M12
No. of Flutes	-	-	-	-	-	-	-	-	-	-
Style	1	1	2	2	2	2	2	2	2	3

Super Sabre

OUR PREMIER HIGH PERFORMANCE COBALT STEEL TAP

Super Sabre Blue

for low to medium carbon steel



Super Sabres are designed to withstand the stress and heat generated by high speed production tapping.

Hardness and performance exceeds that of M2 and M7 and is comparable with that of M35.

Manufactured from a specially adapted low alloy high speed steel with a high C/V ratio for good hot hardness, toughness and wear resistance.



Super Sabre Bright

for aluminium and brass

All Super Sabre Taps are also available in selected UNC, UNF and BSW sizes.



Super Sabre TiN

for increased tool life and abrasive materials



Table Reference Number



Metric/Imperial



Pitch Diameter Tolerance



Class of Fit



Available in:
Taper Lead
Second Lead
Bottom Lead

Spiral Point



	M3	M4	M5	M6	M8	M10	M12	M16	M20	M24
No. of Flutes	3	3	3	3	3	3	3	3	3	3
Style	2	2	2	2	2	2	3	3	3	3

Metric Fine/Super Fine and Non Standard ISO 529



Nominal Major Diameter <i>d</i>	Pitch	Overall Length <i>Lmm</i>	Length of Thread <i>lmm</i>	Shank Diameter <i>d 1mm</i>	Neck Diameter <i>d 2mm</i>	Neck Length <i>l 1mm</i>	Square A/F <i>mm</i>	Square Length <i>l 2mm</i>
M2	0.45	41	8	2.50	-	-	2.00	4
M3	0.35	48	11	3.15	2.12	7	2.50	5
M3	0.60	48	11	3.15	2.12	7	2.50	5
M3.5	0.35	50	13	3.55	2.50	7	2.80	5
M3.5	0.50	50	13	3.55	2.50	7	2.80	5
M4	0.50	53	13	4.00	2.80	8	3.15	6
M4	0.75	53	13	4.00	2.80	8	3.15	6
M4.5	0.50	53	13	4.50	3.15	8	3.55	6
M5	0.50	58	16	5.00	3.55	9	4.00	7
M5	0.75	58	16	5.00	3.55	9	4.00	7
M5	0.90	58	16	5.00	3.55	9	4.00	7
M5	1.00	58	16	5.00	3.55	9	4.00	7
M6	0.50	66	19	6.30	4.50	11	5.00	8
M6	0.75	66	19	6.30	4.50	11	5.00	8
M6	1.25	66	19	6.30	4.50	11	5.00	8
M7	0.50	66	19	7.10	5.30	11	5.60	8
M7	0.75	66	19	7.10	5.30	11	5.60	8
M7	1.25	66	19	7.10	5.30	11	5.60	8
M8	0.50	69	19	8.00	6.00	13	6.30	9
M8	0.75	69	19	8.00	6.00	13	6.30	9
M8	1.00	69	19	8.00	6.00	13	6.30	9
M8	1.50	72	22	8.00	6.00	13	6.30	9
M9	0.75	69	19	9.00	7.10	14	7.10	10
M9	1.00	69	19	9.00	7.10	14	7.10	10
M9	1.50	72	22	9.00	7.10	14	7.10	10
M10	0.50	76	20	10.00	7.50	15	8.00	11
M10	0.75	76	20	10.00	7.50	15	8.00	11
M10	1.00	76	20	10.00	7.50	15	8.00	11
M10	1.25	76	20	10.00	7.50	15	8.00	11
M11	0.75	82	22	8.00	-	-	6.30	9
M11	1.00	82	22	8.00	-	-	6.30	9
M11	1.25	82	22	8.00	-	-	6.30	9
M12	0.50	84	24	9.00	-	-	7.10	10
M12	0.75	84	24	9.00	-	-	7.10	10
M12	1.00	84	24	9.00	-	-	7.10	10
M12	1.25	84	24	9.00	-	-	7.10	10
M12	1.50	89	29	9.00	-	-	7.10	10
M14	1.00	90	25	11.20	-	-	9.00	12
M14	1.25	90	25	11.20	-	-	9.00	12
M14	1.50	95	30	11.20	-	-	9.00	12
M15	1.00	90	25	11.20	-	-	9.00	12
M15	1.25	90	25	11.20	-	-	9.00	12
M15	1.50	95	30	11.20	-	-	9.00	12
M16	1.00	95	25	12.50	-	-	10.00	13
M16	1.25	95	25	12.50	-	-	10.00	13
M16	1.50	102	32	12.50	-	-	10.00	13
M16	1.75	95	25	12.50	-	-	10.00	13

METRIC

HIGH SPEED STEEL
GROUND THREAD

Metric Fine/Super Fine and Non Standard (continued)



ISO 529

METRIC

Nominal Major Diameter <i>d</i>	Pitch	Overall Length <i>Lmm</i>	Length of Thread <i>lmm</i>	Shank Diameter <i>d 1mm</i>	Neck Diameter <i>d 2mm</i>	Neck Length <i>l 1mm</i>	Square A/F <i>mm</i>	Square Length <i>l 2mm</i>
M18	1.00	104	29	14.00	-	-	11.20	14
M18	1.25	104	29	14.00	-	-	11.20	14
M18	1.50	104	29	14.00	-	-	11.20	14
M18	2.00	112	37	14.00	-	-	11.20	14
M20	1.00	104	29	14.00	-	-	11.20	14
M20	1.25	104	29	14.00	-	-	11.20	14
M20	1.50	104	29	14.00	-	-	11.20	14
M20	2.00	112	37	14.00	-	-	11.20	14
M22	1.00	113	33	16.00	-	-	12.50	16
M22	1.25	113	33	16.00	-	-	12.50	16
M22	1.50	113	33	16.00	-	-	12.50	16
M22	2.00	118	38	16.00	-	-	12.50	16
M24	1.00	120	35	18.00	-	-	14.00	18
M24	1.25	120	35	18.00	-	-	14.00	18
M24	1.50	120	35	18.00	-	-	14.00	18
M24	2.00	120	35	18.00	-	-	14.00	18
M25	1.00	120	35	18.00	-	-	14.00	18
M25	1.50	120	35	18.00	-	-	14.00	18
M25	2.00	120	35	18.00	-	-	14.00	18
M27	1.50	127	37	20.00	-	-	16.00	20
M27	2.00	127	37	20.00	-	-	16.00	20
M28	1.50	127	37	20.00	-	-	16.00	20
M30	1.50	127	37	20.00	-	-	16.00	20
M30	2.00	127	37	20.00	-	-	16.00	20
M30	3.00	138	48	20.00	-	-	16.00	20
M32	1.50	137	37	22.40	-	-	18.00	22
M33	1.50	137	37	22.40	-	-	18.00	22
M33	2.00	137	37	22.40	-	-	18.00	22
M33	3.00	151	51	22.40	-	-	18.00	22
M36	1.50	144	39	25.00	-	-	20.00	24
M36	2.00	144	39	25.00	-	-	20.00	24
M36	3.00	162	57	25.00	-	-	20.00	24
M39	1.50	149	39	28.00	-	-	22.40	26
M39	2.00	149	39	28.00	-	-	22.40	26
M39	3.00	170	60	28.00	-	-	22.40	26
M40	1.50	149	39	28.00	-	-	22.40	26
M42	1.50	149	39	28.00	-	-	22.40	26
M42	3.00	170	60	28.00	-	-	22.40	26
M45	1.50	165	45	31.50	-	-	25.00	28
M45	3.00	187	67	31.50	-	-	25.00	28
M48	1.50	165	45	31.50	-	-	25.00	28
M48	2.00	187	67	31.50	-	-	25.00	28
M48	3.00	187	67	31.50	-	-	25.00	28

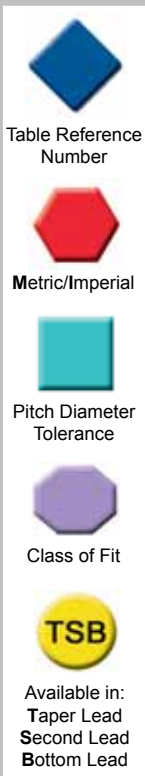

Straight Flute (Fine)



	M2 0.45	M3 0.35	M3 0.6	M3.5 0.35	M3.5 0.50	M4 0.50	M4 0.75	M4.5 0.75	M5 0.50	M5 0.75	M5 0.90	M5 1.00	M6 0.50	M6 0.75
No. of Flutes	3	3	3	3	3	3	3	3	3	3	3	3	3	3
Style	1	2	2	2	2	2	2	2	2	2	2	2	2	2

	M6 1.25	M7 0.50	M7 0.75	M7 1.25	M8 0.50	M8 0.75	M8 1.00	M8 1.50	M9 0.75	M9 1.00	M9 1.50	M10 0.50	M10 0.75	M10 1.00
No. of Flutes	3	4	4	4	4	4	4	4	4	4	4	4	4	4
Style	2	2	2	2	2	2	2	2	2	2	2	2	2	2

	M10 1.25	M11 0.75	M11 1.00	M11 1.25	M12 0.50	M12 0.75	M12 1.00	M12 1.25	M12 1.50	M14 1.00	M14 1.25	M14 1.50	M15 1.00	M15 1.25
No. of Flutes	4	4	4	4	4	4	4	4	4	4	4	4	4	4
Style	2	3	3	3	3	3	3	3	3	3	3	3	3	3

	M15 1.50	M16 1.00	M16 1.25	M16 1.50	M16 1.75	M18 1.00	M18 1.25	M18 1.50	M18 2.00	M20 1.00	M20 1.25	M20 1.50	M20 2.00	M22 1.00
No. of Flutes	4	4	4	4	4	4	4	4	4	4	4	4	4	4
Style	3	3	3	3	3	3	3	3	3	3	3	3	3	3

	M22 1.25	M22 1.50	M22 2.00	M24 1.00	M24 1.25	M24 1.50	M24 2.00	M25 1.00	M25 1.50	M25 2.00	M27 1.50	M27 2.00	M28 1.50	M30 1.50
No. of Flutes	4	4	4	4	4	4	4	4	4	4	4	4	4	6
Style	3	3	3	3	3	3	3	3	3	3	3	3	3	3

	M30 2.00	M30 3.00	M32 1.50	M33 1.50	M33 2.00	M33 3.00	M36 1.50	M36 2.00	M36 3.00	M39 1.50	M39 2.00	M39 3.00	M40 1.50	M42 1.50
No. of Flutes	6	4	6	6	6	6	6	6	4	6	6	6	6	6
Style	3	3	3	3	3	3	3	3	3	3	3	3	3	3

	M42 3.00	M45 1.50	M45 3.00	M48 1.50	M48 2.00	M48 3.00
No. of Flutes	6	6	6	6	6	6
Style	3	3	3	3	3	3

Spiral Point (Fine)



	M4 0.50	M5 0.50	M6 0.75	M8 1.0	M10 1.0	M10 1.25	M12 1.25	M12 1.5	M14 1.25	M14 1.5	M16 1.5	M18 1.5	M20 1.5	M22 1.5
No. of Flutes	2	2	2	3	3	3	3	3	3	3	3	3	3	3
Style	2	2	2	2	2	2	2	2	3	3	3	3	3	3

Spiral Flute (Fine)



	M4 0.50	M5 0.50	M6 0.75	M8 1.0	M10 1.0	M10 1.25	M12 1.25	M12 1.5	M14 1.25	M14 1.5	M16 1.5	M18 1.5	M20 1.5	M22 1.5
No. of Flutes	2	3	3	3	3	3	3	3	3	3	3	3	3	3
Style	2	2	2	2	2	2	3	3	3	3	3	3	3	3

METRIC

HIGH SPEED STEEL
GROUND THREAD

DIN 371 HSS - Co

Reinforced Shank (Coarse)

Available in - Bottom Lead, Spiral Point, Spiral Flute

STYLE 4



Nominal Major Diameter <i>d</i>	Pitch	Overall Length <i>L mm</i>	Length of Thread <i>l mm</i>	Shank Diameter <i>d 1mm</i>	Square A/F <i>mm</i>	Square Length <i>l 2mm</i>
M3	0.50	56	11	3.5	2.7	6
M4	0.70	63	13	4.5	3.4	6
M5	0.80	70	16	6.0	4.9	8
M6	1.00	80	19	6.0	4.9	8
M8	1.25	90	22	8.0	6.2	9
M10	1.50	100	24	10.0	8.0	11



DIN 376 HSS - Co

Reduced Shank (Coarse)

Available in - Bottom Lead, Spiral Point, Spiral Flute

STYLE 5



Nominal Major Diameter <i>d</i>	Pitch	Overall Length <i>L mm</i>	Length of Thread <i>l mm</i>	Shank Diameter <i>d 1mm</i>	Square A/F <i>mm</i>	Square Length <i>l 2mm</i>
M3	0.50	56	11	2.2	-	-
M4	0.70	63	13	2.8	2.10	5
M5	0.80	70	16	3.5	2.70	6
M6	1.00	80	19	4.5	3.40	6
M8	1.25	90	22	6.0	4.90	8
M10	1.50	100	24	7.0	5.50	8
M12	1.75	110	29	9.0	7.00	10
M14	2.00	110	30	11.0	9.00	11
M16	2.00	110	32	12.0	9.00	12
M18	2.50	125	34	14.0	11.00	14
M20	2.50	140	34	16.0	12.00	15



DIN 374 HSS - Co

Reduced Shank (Fine)

Available in - Bottom Lead, Spiral Point

STYLE 5



Nominal Major Diameter <i>d</i>	Pitch	Overall Length <i>L mm</i>	Length of Thread <i>l mm</i>	Shank Diameter <i>d 1mm</i>	Square A/F <i>mm</i>	Square Length <i>l 2mm</i>
M8	1.00	90	22	6.00	6.00	8
M10	1.00	90	20	7.00	5.50	8
M10	1.25	100	24	7.00	5.50	8
M12	1.00	100	22	9.00	7.00	10
M12	1.25	100	22	9.00	7.00	10
M12	1.50	110	29	9.00	7.00	10
M14	1.50	100	22	11.00	9.00	12
M16	1.50	100	22	12.00	9.00	12
M18	1.50	110	25	14.00	11.00	14
M20	1.50	125	25	16.00	12.00	15
M22	1.50	125	25	18.00	14.50	17
M24	1.50	125	25	18.00	14.50	17



METRIC



Table Reference Number



Metric/Imperial



Pitch Diameter Tolerance



Class of Fit



Available in:
Taper Lead
Second Lead
Bottom Lead

Nominal Major Diameter d / inches	TPI	Overall Length Lmm	Length of Thread lmm	Shank Diameter d 1mm	Neck Diameter d 2mm	Neck Length l 1mm	Square A/F mm	Square Length l 2mm
No. 1	64	41	8	2.50	-	5.5	2	4
No. 2	56	44.5	9.5	2.80	-	6	2.24	5
No. 3	48	44.5	9.5	2.80	-	6	2.24	5
No. 4	40	48	11	3.15	2.12	7	2.5	5
No. 5	40	48	11	3.15	2.36	7	2.5	5
No. 6	32	50	13	3.55	2.50	7	2.8	5
No. 8	32	53	13	4.50	3.15	8	3.55	6
No. 10	24	58	16	5.00	3.55	9	4	7
No. 12	24	62	17	5.60	4.25	9	4.5	7
1/4	20	66	19	6.30	4.50	11	5	8
5/16	18	72	22	8.00	6.00	13	6.3	9
3/8	16	80	24	10.00	7.50	15	8	11
7/16	14	85	25	8.00	-	-	6.3	9
1/2	13	89	29	9.00	-	-	7.1	10
9/16	12	95	30	11.20	-	-	9	12
5/8	11	102	32	12.50	-	-	10	13
3/4	10	112	37	14.00	-	-	11.2	14
7/8	9	118	38	16.00	-	-	12.5	16
1	8	130	45	18.00	-	-	14	18
1 1/8	7	138	48	20.00	-	-	16	20
1 1/4	7	151	51	22.40	-	-	18	22
1 3/8	6	162	57	25.00	-	-	20	24
1 1/2	6	170	60	28.00	-	-	22.4	26
1 3/4	5	187	67	31.50	-	-	25	28
2	4.5	200	70	35.5	-	-	28	31

Straight Flute



	No. 1	No. 2	No. 3	No. 4	No. 5	No. 6	No. 8	No. 10	No. 12	1/4
No. of Flutes	3	3	3	3	3	3	3	3	3	3
Style	1	1	1	2	2	2	2	2	2	2

	5/16	3/8	7/16	1/2	9/16	5/8	3/4	7/8	1	1 1/8
No. of Flutes	4	4	4	4	4	4	4	4	4	4
Style	2	2	3	3	3	3	3	3	3	3

	1 1/4	1 3/8	1 1/2	1 3/4	2
No. of Flutes	4	4	4	6	6
Style	3	3	3	3	3

HIGH SPEED STEEL
GROUND THREAD

UNC

Straight Flute - Left Hand



	1/4	5/16	3/8	7/16	1/2	5/8	3/4	1
No. of Flutes	3	4	4	4	4	4	4	4
Style	2	2	2	3	3	3	3	3

Spiral Point



	No. 1	No. 2	No. 3	No. 4	No. 5	No. 6	No. 8	No. 10	No. 12	1/4
No. of Flutes	2	2	2	2	2	2	2	2	2	2
Style	1	1	1	2	2	2	2	2	2	2

	5/16	3/8	7/16	1/2	9/16	5/8	3/4	7/8	1
No. of Flutes	3	3	3	3	3	3	3	3	3
Style	2	2	3	3	3	3	3	3	3

Spiral Flute



	No. 4	No. 5	No. 6	No. 8	No. 10	1/4	5/16	3/8	7/16	1/2
No. of Flutes	2	2	2	2	2	2	2	2	3	3
Style	2	2	2	2	2	2	2	2	3	3

	9/16	5/8	3/4	7/8	1
No. of Flutes	3	3	3	3	3
Style	3	3	3	3	3

Fluteless



	No. 2	No. 4	No. 5	No. 6	No. 8	No. 10	1/4	5/16	3/8	1/2
No. of Flutes	-	-	-	-	-	-	-	-	-	-
Style	1	2	2	2	2	2	2	2	2	3





Nominal Major Diameter d / inches	TPI	Pitch Diameter Tolerance	Overall Length L ins	Length of Thread l ins	Shank Diameter d 1ins	Square A/F ins	Square Length l 2ins
No. 1	64	GH1	1.687	0.375	0.141	0.110	0.187
No. 2	56	GH1	1.750	0.437	0.141	0.110	0.187
No. 3	48	GH2	1.812	0.500	0.141	0.110	0.187
No. 4	40	GH2	1.875	0.562	0.141	0.110	0.187
No. 5	40	GH2	1.937	0.625	0.141	0.110	0.187
No. 6	32	GH3	2.000	0.687	0.141	0.110	0.141
No. 8	32	GH3	2.125	0.750	0.168	0.131	0.250
No. 10	24	GH3	2.375	0.875	0.194	0.152	0.250
No. 12	24	GH3	2.375	0.937	0.220	0.165	0.281
1/4	20	GH3	2.500	1.000	0.255	0.191	0.312
5/16	18	GH3	2.718	1.125	0.318	0.238	0.375
3/8	16	GH3	2.937	1.250	0.381	0.286	0.437
7/16	14	GH3	3.156	1.437	0.323	0.242	0.406
1/2	13	GH3	3.375	1.656	0.367	0.275	0.437
9/16	12	GH3	3.593	1.656	0.429	0.322	0.500
5/8	11	GH3	3.812	1.812	0.480	0.360	0.562
3/4	10	GH3	4.250	2.000	0.590	0.442	0.687
7/8	9	GH4	4.687	2.218	0.697	0.523	0.750
1	8	GH4	5.125	2.500	0.800	0.600	0.812
1	14	GH4	5.125	2.500	0.800	0.600	0.812
1 1/8	7	GH4	5.437	2.562	0.896	0.672	0.875
1 1/4	7	GH4	5.750	2.562	1.021	0.766	1.000
1 3/8	6	GH4	6.062	3.000	1.108	0.831	1.062
1 1/2	6	GH4	6.375	3.000	1.233	0.925	1.125
2	4.5	GH4	7.625	3.562	1.644	1.233	1.375

Straight Flute



No.1-2 No.3-5 No.6-3/4 7/8-2

	No. 1	No. 2	No. 3	No. 4	No. 5	No. 6	No. 8	No. 10	No. 12	1/4
No. of Flutes	2	3	3	3	3	3	4	4	4	4
Style	6	6	6	6	6	6	6	6	6	7

	5/16	3/8	7/16	1/2	9/16	5/8	3/4	7/8	1	1 1/8
No. of Flutes	4	4	4	4	4	4	4	4	4	4
Style	7	7	8	8	8	8	8	8	8	8

	1 1/4	1 3/8	1 1/2	1 3/4	2
No. of Flutes	4	4	4	4	6
Style	8	8	8	8	8

HIGH SPEED STEEL
GROUND THREAD

Spiral Point



No.1-2

No.3-5

No.6-3/4

7/8-2

	No. 1	No. 2	No. 3	No. 4	No. 5	No. 6	No. 8	No. 10	No. 12	1/4
No. of Flutes	2	2	2	2	2	2	2	2	2	2 or 3
Style	6	6	6	6	6	6	6	6	6	7

	5/16	3/8	7/16	1/2	9/16	5/8	3/4	7/8	1
No. of Flutes	3	3	3	3	3	3	3	3	3
Style	7	7	8	8	8	8	8	8	8

Spiral Flute



No.5

No.6-3/4

7/8-2

	No. 5	No. 6	No. 8	No. 10	No. 12	1/4	5/16	3/8	7/16	1/2
No. of Flutes	2	2	2	3	3	3	3	3	3	3
Style	6	6	6	6	6	7	7	7	8	8

	9/16	5/8	3/4	7/8	1
No. of Flutes	3	3	3	3	3
Style	8	8	8	8	8



Table Reference Number



Metric/Imperial



Pitch Diameter Tolerance



Class of Fit



Available in:
Taper Lead
Second Lead
Bottom Lead



Nominal Major Diameter d / inches	TPI	Overall Length L mm	Length of Thread l mm	Shank Diameter d 1mm	Neck Diameter d 2mm	Neck Length l 1mm	Square A/F mm	Square Length l 2mm
No. 0	80	41	8	2.5	-	5	2	4
No. 1	72	41	8	2.5	-	5.5	2	4
No. 2	64	44.5	9.5	2.8	-	6	2.24	5
No. 3	56	44.5	9.5	2.8	-	6	2.24	5
No. 4	48	48	11	3.15	2.12	7	2.5	5
No. 5	44	48	11	3.15	2.36	7	2.5	5
No. 6	40	50	13	3.55	2.5	7	2.8	5
No. 8	36	53	13	4.5	3.15	8	3.55	6
No. 10	32	58	16	5	3.55	9	4	7
No. 12	28	62	17	5.6	4.25	9	4.5	7
1/4	28	66	19	6.3	4.5	11	5	8
5/16	24	69	19	8	6	13	6.3	9
3/8	24	76	20	10	7.5	15	8	11
7/16	20	82	22	8	-	-	6.3	9
1/2	20	84	24	9	-	-	7.1	10
9/16	18	90	25	11.2	-	-	9	12
5/8	18	95	25	12.5	-	-	10	13
3/4	16	104	29	14	-	-	11.2	14
7/8	14	113	33	16	-	-	12.5	16
1	12	120	35	18	-	-	14	18
1 1/8	12	127	37	20	-	-	16	20
1 1/4	12	137	37	22.4	-	-	18	22
1 3/8	12	144	39	25	-	-	20	24
1 1/2	12	149	39	28	-	-	22.4	26

Straight Flute



	No. 0	No. 1	No. 2	No. 3	No. 4	No. 5	No. 6	No. 8	No. 10	No. 12
No. of Flutes	3	3	3	3	3	3	3	3	3	3
Style	1	1	1	1	2	2	2	2	2	2

	1/4	5/16	3/8	7/16	1/2	9/16	5/8	3/4	7/8	1
No. of Flutes	3	4	4	4	4	4	4	4	4	4
Style	2	2	2	3	3	3	3	3	3	3

	1 1/8	1 1/4	1 3/8	1 1/2
No. of Flutes	4	4	4	4
Style	3	3	3	3

UNF

HIGH SPEED STEEL
GROUND THREAD

Straight Flute - Left Hand



	No. 10	1/4	5/16	3/8	7/16	1/2	5/8	3/4	7/8	1
No. of Flutes	3	3	4	4	4	4	4	4	4	4
Style	2	2	2	2	3	3	3	3	3	3

Spiral Point



	No. 0	No. 1	No. 2	No. 3	No. 4	No. 5	No. 6	No. 8	No. 10	No. 12
No. of Flutes	2	2	2	2	2	2	2	2	2	2
Style	1	1	1	1	2	2	2	2	2	2

	1/4	5/16	3/8	7/16	1/2	9/16	5/8	3/4	7/8	1
No. of Flutes	3	3	3	3	3	3	3	3	3	3
Style	2	2	2	3	3	3	3	3	3	3

Spiral Flute



	No. 4	No. 5	No. 6	No. 8	No. 10	1/4	5/16	3/8	7/16	1/2
No. of Flutes	2	2	2	2	3	3	3	3	3	3
Style	2	2	2	2	2	2	2	2	3	3

	9/16	5/8	3/4	7/8	1
No. of Flutes	3	3	3	3	3
Style	3	3	3	3	3

Fluteless



	No. 2	No. 4	No. 6	No. 8	No. 10	1/4	5/16	3/8	7/16	1/2
No. of Flutes	-	-	-	-	-	-	-	-	-	-
Style	1	2	2	2	2	2	2	2	3	3

Table Reference Number

Metric/Imperial

Pitch Diameter Tolerance

Class of Fit

TSB

Available in:
Taper Lead
Second Lead
Bottom Lead



Nominal Major Diameter <i>d</i> / inches	TPI	Overall Length <i>L</i> ins	Length of Thread <i>l</i> ins	Shank Diameter <i>d</i> 1ins	Square A/F ins	Square Length <i>l</i> 2ins
No. 1	72	1.687	0.375	0.141	0.110	0.187
No. 2	64	1.750	0.437	0.141	0.110	0.187
No. 3	56	1.812	0.500	0.141	0.110	0.187
No. 4	48	1.875	0.562	0.141	0.110	0.187
No. 5	44	1.937	0.625	0.141	0.110	0.187
No. 6	40	2.000	0.687	0.141	0.110	0.141
No. 8	36	2.125	0.750	0.168	0.131	0.250
No. 10	32	2.375	0.875	0.194	0.152	0.250
No. 12	28	2.375	0.937	0.220	0.165	0.281
1/4	28	2.500	1.000	0.255	0.191	0.312
5/16	24	2.718	1.125	0.318	0.238	0.375
3/8	24	2.937	1.250	0.381	0.286	0.437
7/16	20	3.156	1.437	0.323	0.242	0.406
1/2	20	3.375	1.656	0.367	0.275	0.437
9/16	18	3.593	1.656	0.429	0.322	0.500
5/8	18	3.812	1.812	0.480	0.360	0.562
3/4	16	4.250	2.000	0.590	0.442	0.687
7/8	14	4.687	2.218	0.697	0.523	0.750
1	12	5.125	2.500	0.800	0.600	0.812
1	14	5.125	2.500	0.800	0.600	0.812
1 1/8	12	5.437	2.562	0.896	0.672	0.875
1 1/4	12	5.750	2.562	1.021	0.766	1.000
1 3/8	12	6.062	3.000	1.108	0.831	1.062
1 1/2	12	6.375	3.000	1.233	0.925	1.125

Straight Flute



No.1-2 No.3-5 No.6-3/4 7/8-1 1/2

	No. 1	No. 2	No. 3	No. 4	No. 5	No. 6	No. 8	No. 10	No. 12	1/4
No. of Flutes	2	3	3	3	3	3	4	4	4	4
Style	6	6	6	6	6	6	6	6	6	7

	5/16	3/8	7/16	1/2	9/16	5/8	3/4	7/8	1	1 1/8
No. of Flutes	4	4	4	4	4	4	4	4	4	4
Style	7	7	8	8	8	8	8	8	8	8

	1 1/4	1 3/8	1 1/2
No. of Flutes	4	4	4
Style	8	8	8

Spiral Point



No.1-2

No.3-5

No.6-3/4

7/8-1

	No. 1	No. 2	No. 3	No. 4	No. 5	No. 6	No. 8	No. 10	No. 12	1/4
No. of Flutes	2	2	2	2	2	2	2	2	2	2 or 3
Style	6	6	6	6	6	6	6	6	6	7

	5/16	3/8	7/16	1/2	9/16	5/8	3/4	7/8	1
No. of Flutes	3	3	3	3	3	3	3	3	3
Style	7	7	8	8	8	8	8	8	8

Spiral Flute



No.5

No.6-3/4

7/8-1

	No. 5	No. 6	No. 8	No. 10	No. 12	1/4	5/16	3/8	7/16	1/2
No. of Flutes	2	2	2	3	3	3	3	3	3	3
Style	6	6	6	6	6	7	7	7	8	8

	9/16	5/8	3/4	7/8	1
No. of Flutes	3	3	3	3	3
Style	8	8	8	8	8



Table Reference Number



Metric/Imperial



Pitch Diameter Tolerance



Class of Fit



Available in:
Taper Lead
Second Lead
Bottom Lead



Nominal Major Diameter d / inches	TPI	Overall Length L mm	Length of Thread l mm	Shank Diameter d 1mm	Neck Diameter d 2mm	Neck Length l 1mm	Square A/F mm	Square Length l 2mm
1/16	60	41	8	2.50	-	5	2	4
3/32	48	44.5	9.5	2.80	-	6	2.24	5
1/8	40	48	11	3.15	2.36	7	2.5	5
5/32	32	53	13	4.00	2.80	8	3.15	6
3/16	24	58	16	5.00	3.55	9	4	7
7/32	24	62	17	5.60	4.25	9	4.5	7
1/4	20	66	19	6.30	4.50	11	5	8
5/16	18	72	22	8.00	6.00	13	6.3	9
3/8	16	80	24	10.00	7.50	15	8	11
7/16	14	85	25	8.00	-	-	6.3	9
1/2	12	89	29	9.50	-	-	7.5	10
9/16	12	95	30	11.20	-	-	9	12
5/8	11	102	32	12.50	-	-	10	13
3/4	10	112	37	14.00	-	-	11.2	14
7/8	9	118	38	16.00	-	-	12.5	16
1	8	130	45	18.00	-	-	14	18
1 1/8	7	138	48	20.00	-	-	16	20
1 1/4	7	151	51	22.40	-	-	18	22
1 3/8	6	162	57	25.00	-	-	20	24
1 1/2	6	170	60	28.00	-	-	22.4	26
1 5/8	5	170	60	28.00	-	-	22.4	26
1 3/4	5	187	67	31.50	-	-	25	28
1 7/8	4.5	187	67	31.50	-	-	25	28
2	4.5	200	70	35.50	-	-	28	31

Straight Flute



	1/16	3/32	1/8	5/32	3/16	7/32	1/4	5/16	3/8	7/16
No. of Flutes	3	3	3	3	3	3	3	3	4	4
Style	1	1	2	2	2	2	2	2	2	3

	1/2	9/16	5/8	3/4	7/8	1	1 1/8	1 1/4	1 3/8	1 1/2
No. of Flutes	4	4	4	4	4	4	4	4	4	4
Style	3	3	3	3	3	3	3	3	3	3

	1 5/8	1 3/4	1 7/8	2
No. of Flutes	6	6	6	6
Style	3	3	3	3

Straight Flute - Left Hand



	1/4	5/16	3/8	7/16	1/2	5/8	3/4	7/8	1
No. of Flutes	3	4	4	4	4	4	4	4	4
Style	2	2	2	3	3	3	3	3	3

Spiral Point



	1/8	5/32	3/16	1/4	5/16	3/8	7/16	1/2	9/16	5/8
No. of Flutes	2	2	2	2	3	3	3	3	3	3
Style	2	2	2	2	2	2	3	3	3	3

	3/4	7/8	1
No. of Flutes	3	3	3
Style	3	3	3

Spiral Flute



	1/8	5/32	3/16	1/4	5/16	3/8	7/16	1/2	5/8	3/4
No. of Flutes	2	2	3	3	3	3	3	3	3	3
Style	2	2	2	2	2	2	3	3	3	3

	7/8	1
No. of Flutes	3	3
Style	3	3

Fluteless



	1/8	3/16	1/4	5/16	3/8
No. of Flutes	-	-	-	-	-
Style	2	2	2	2	2

Table Reference Number



Metric/Imperial



Pitch Diameter Tolerance



Class of Fit



Available in:
Taper Lead
Second Lead
Bottom Lead

Nominal Major Diameter <i>d</i> / inches	TPI	Overall Length <i>L</i> mm	Length of Thread <i>l</i> mm	Shank Diameter <i>d</i> 1mm	Neck Diameter <i>d</i> 2mm	Neck Length <i>l</i> 1mm	Square A/F <i>mm</i>	Square Length <i>l</i> 2mm
3/16	32	58	16	5	3.55	9	4	7
1/4	26	66	19	6.3	4.5	11	5	8
5/16	22	72	22	8	6	13	6.3	9
3/8	20	80	24	10	7.5	15	8	11
7/16	18	85	25	8	-	-	6.3	9
1/2	16	89	29	9.5	-	-	7.5	10
9/16	16	95	30	11.2	-	-	9	12
5/8	14	102	32	12.5	-	-	10	13
3/4	12	112	37	14	-	-	11.2	14
7/8	11	118	38	16	-	-	12.5	16
1	10	130	45	18	-	-	14	18
1 1/8	9	138	48	20	-	-	16	20
1 1/4	9	151	51	22.4	-	-	18	22
1 3/8	8	162	57	25	-	-	20	24
1 1/2	8	170	60	28	-	-	22.4	26
1 3/4	7	187	67	31.5	-	-	25	28
2	7	200	70	35.5	-	-	28	31

Straight Flute



	3/16	1/4	5/16	3/8	7/16	1/2	9/16	5/8	3/4
No. of Flutes	3	3	4	4	4	4	4	4	4
Style	2	2	2	2	3	3	3	3	3

	1	1 1/8	1 1/4	1 3/8	1 1/2	1 3/4	2
No. of Flutes	4	4	4	4	4	6	6
Style	3	3	3	3	3	3	3

Straight Flute - Left Hand



	1/4	5/16	3/8	7/16	1/2	5/8	3/4	7/8	1
No. of Flutes	3	4	4	4	4	4	4	4	4
Style	2	2	2	3	3	3	3	3	3

Spiral Point



	3/16	1/4	5/16	3/8	7/16	1/2	9/16	5/8	3/4	7/8
No. of Flutes	2	2	3	3	3	3	3	3	3	3
Style	2	2	2	2	3	3	3	3	3	3

	1
No. of Flutes	3
Style	3

Spiral Flute



	3/16	1/4	5/16	3/8	7/16	1/2	5/8	3/4	7/8	1
No. of Flutes	2	3	3	3	3	3	3	3	3	3
Style	2	2	2	2	3	3	3	3	3	3

Fluteless



	1/4	5/16	3/8
No. of Flutes	-	-	-
Style	2	2	2



Table Reference Number



Metric/Imperial



Pitch Diameter Tolerance



Class of Fit



Available in:
Taper Lead
Second Lead
Bottom Lead

Nom Size BA	Nominal Major Diameter d / mm	TPI	Overall Length Lmm	Length of Thread lmm	Shank Diameter d 1mm	Neck Diameter d 2mm	Neck Length l 1mm	Square A/F mm	Square Length l 2mm
0	6.000	25.4	66	19	6.3	4.5	11	5.00	8
1	5.300	28.2	62	17	5.6	4.25	9	4.50	7
2	4.700	31.4	58	16	5	3.55	9	4.00	7
3	4.100	34.8	53	13	4.5	3.15	8	3.55	6
4	3.600	38.5	50	13	3.55	2.5	7	2.80	5
5	3.200	43	48	11	3.15	2.12	7	2.50	5
6	2.800	47.9	44.5	9.5	2.8	-	6	2.24	5
7	2.500	52.9	44.5	9.5	2.8	-	6	2.24	5
8	2.200	59.1	44.5	9.5	2.8	-	6	2.24	5
9	1.900	65.1	41	8	2.5	-	5.5	2.00	4
10	1.700	72.6	41	8	2.5	-	5	2.00	4
12	1.300	90.9	40	7	2.5	-	5	2.00	4

Straight Flute



	0	1	2	3	4	5	6	7	8	9
No. of Flutes	3	3	3	3	3	3	3	3	3	3
Style	2	2	2	2	2	2	1	1	1	1

	10	12
No. of Flutes	3	3
Style	1	1

Straight Flute - Left Hand



	0	2	4
No. of Flutes	3	3	3
Style	2	2	2

Spiral Point



	0	1	2	3	4	5	6	7	8	10
No. of Flutes	2	2	2	2	2	2	2	2	2	2
Style	2	2	2	2	2	2	1	1	1	1

Spiral Flute - BA



	0	1	2	3	4	5	6	8	10
No. of Flutes	3	3	3	2	2	2	2	2	2
Style	2	2	2	2	2	2	1	1	1

Fluteless - BA



	0	2	4	6	8
No. of Flutes	-	-	-	-	-
Style	2	2	2	1	1

BSB (British Standard Brass)

BS949-1969







Nominal Major Diameter <i>d / inches</i>	TPI	Overall Length <i>Lmm</i>	Length of Thread <i>lmm</i>	Shank Diameter <i>d 1mm</i>	Neck Diameter <i>d 2mm</i>	Neck Length <i>l 1mm</i>	Square A/F <i>mm</i>	Square Length <i>l 2mm</i>
*1/4	26	66	19	6.3	4.5	11	5	8
5/16	26	69	19	8	6	13	6.3	9
3/8	26	76	20	10	7.5	15	8	11
7/16	26	82	22	8	-	-	6.3	9
1/2	26	84	24	9	-	-	7.1	10
9/16	26	90	25	11.2	-	-	9	12
5/8	26	95	25	12.5	-	-	10	13
3/4	26	104	29	14	-	-	11.2	14
7/8	26	113	33	16	-	-	12.5	16
1	26	120	35	18	-	-	14	18

* 1/4" BSB identical to 1/4" BSF

Straight Flute - BSB



	1/4	5/16	3/8	7/16	1/2	9/16	5/8	3/4	7/8	1
No. of Flutes	3	4	4	4	4	4	4	4	4	4
Style	2	2	2	3	3	3	3	3	3	3

-  Table Reference Number
-  Metric/Imperial
-  Pitch Diameter Tolerance
-  Class of Fit
-  TSB

Available in:
Taper Lead
Second Lead
Bottom Lead

BSPF (For non-fuel connections - BS2779)

BS949-1969 British Standard Pipe - BSPF



Nominal Size	TPI	Basic Major Dia <i>d ins</i>	Overall Length <i>L ins</i>	Length of Thread <i>l ins</i>	Shank Diameter <i>d 1 ins</i>	Square A/F <i>ins</i>	Square Length <i>l 2 ins</i>
1/8	28	0.383	2.125	0.75	0.318	0.238	0.312
1/4	19	0.518	2.437	1.062	0.429	0.322	0.437
3/8	19	0.656	2.562	1.062	0.542	0.406	0.500
1/2	14	0.825	3.125	1.375	0.687	0.515	0.625
5/8	14	0.902	3.187	1.375	0.800	0.600	0.687
3/4	14	1.041	3.250	1.375	0.906	0.679	0.687
7/8	14	1.189	3.500	1.562	1.093	0.812	0.750
1	11	1.309	3.750	1.750	1.125	0.843	0.812
1 1/4	11	1.650	4.000	1.750	1.312	0.984	0.937
1 1/2	11	1.882	4.250	1.750	1.500	1.125	1.000
1 3/4	11	2.116	4.375	1.750	1.625	1.218	1.062
2	11	2.347	4.500	1.750	1.875	1.406	1.125
2 1/4	11	2.587	5.000	2.125	2.000	1.500	1.187
2 1/2	11	2.960	5.500	2.562	2.250	1.687	1.250
3	11	3.460	6.000	2.625	2.625	1.968	1.375

Straight Flute BSPF



	1/8	1/4	3/8	1/2	5/8	3/4	7/8	1	1 1/4	1 1/2
No. of Flutes	4	4	4	4	4	4	4	6	6	6

	1 3/4	2	2 1/4	2 1/2	3
No. of Flutes	6	6	6	6	6

Spiral Point BSPF



	1/8	1/4	3/8	1/2	3/4
No. of Flutes	3	3	3	3	3

Spiral Flute BSPF



	1/8	1/4	3/8	1/2	3/4
No. of Flutes	3	3	3	3	3

PIPE TAPPS

HIGH SPEED STEEL
GROUND THREAD

“G” Series - (For non-fuel connections - BS2779)



ISO - BSPF

BS949: Part 3: 1982 ISO 2284-1976

Nominal Size	TPI	Nominal Major Dia d mm	Overall Length Lmm	Length of Thread lmm	Shank Diameter d 1mm	Square A/F mm	Square Length l 2mm
1/8	28	9.728	59	15	8.00	6.30	9
1/4	19	13.157	67	19	10.00	8.00	11
3/8	19	16.662	75	21	12.50	10.00	13
1/2	14	20.955	87	26	16.00	12.50	16
5/8	14	22.911	91	26	18.00	14.00	18
3/4	14	26.441	96	28	20.00	16.00	20
7/8	14	30.201	102	29	22.40	18.00	22
1	11	33.249	109	33	25.00	20.00	24
1 1/4	11	41.910	119	36	31.50	25.00	28
1 1/2	11	47.803	125	37	35.50	28.00	31
1 3/4	11	53.746	132	39	35.50	28.00	31
2	11	59.614	140	41	40.00	31.50	34

PIPE TAPS

Straight Flute “G” Series - ISO (BSPF)



STYLE 3



	1/8	1/4	3/8	1/2	5/8	3/4	7/8	1	1 1/4	1 1/2
No. of Flutes	4	4	4	4	4	4	4	6	6	6

Spiral Point “G” Series - ISO (BSPF)



STYLE 3



	1/4	3/8	1/2	3/4
No. of Flutes	3	3	3	3

Spiral Flute “G” Series - ISO (BSPF)



STYLE 3



	1/4	3/8	1/2	3/4
No. of Flutes	3	3	3	3

- Table Reference Number
- Metric/Imperial
- Pitch Diameter Tolerance
- Class of Fit
- Available in:
Taper Lead
Second Lead
Bottom Lead

BSPT For Pressure Tight Joints BS 21

BS949-1969



Nominal Size	TPI	Basic / Gauge Thread dia ins	Diameter at large end of tap ins	Overall Length L ins	Length of Thread l ins	Length of Square l 2 ins	Square A/F ins	Diameter of Shank d 1 ins
1/8	28	0.383	0.3986	2.125	0.750	0.312	0.238	0.318
1/4	19	0.518	0.5336	2.437	1.062	0.437	0.322	0.429
3/8	19	0.656	0.6716	2.562	1.062	0.500	0.406	0.542
1/2	14	0.825	0.8484	3.125	1.375	0.625	0.515	0.687
3/4	14	1.041	1.0694	3.250	1.375	0.687	0.679	0.906
1	11	1.309	1.3402	3.750	1.750	0.812	0.843	1.125
1 1/4	11	1.650	1.6812	4.000	1.750	0.937	0.984	1.312
1 1/2	11	1.882	1.9132	4.250	1.750	1.000	1.125	1.500
2	11	2.347	2.3782	4.500	1.750	1.125	1.406	1.875

Straight Flute - BSPT



STYLE 9



	1/8	1/4	3/8	1/2	3/4	1	1 1/4	1 1/2	2
No. of Flutes	4	4	4	4	5	5	5	7	7

“Rc” Series - ISO (BSPT)

For Pressure Tight Joints BS 21

BS949: Part 3: 1982 ISO 2284-1976



Nominal Size	TPI	Nominal Major Dia d mm	Overall Length Lmm	Length of Thread lmm	Shank Diameter d 1mm	Square A/F mm	Square Length l 2mm
1/8	28	9.728	59	15	8	6.3	9
1/4	19	13.157	67	19	10	8	11
3/8	19	16.662	75	21	12.5	10	13
1/2	14	20.955	87	26	16	12.5	16
3/4	14	26.441	96	28	20	16	20
1	11	33.249	109	33	25	20	24
1 1/4	11	41.91	119	36	31.5	25	28
1 1/2	11	47.803	125	37	35.5	28	31
2	11	59.614	140	41	40	31.5	34

Straight Flute - “Rc” Series - ISO (BSPT)



STYLE 3



	1/8	1/4	3/8	1/2	3/4	1	1 1/4	1 1/2	2
No. of Flutes	4	4	4	4	5	5	5	7	7

NPT - NPTF "Dryseal" - NPS - NPSF "Dryseal" BS949-1969



PIPE TAPS

Nominal Size	TPI	Basic / Gauge Thread dia ins	Diameter at large end of tap ins	Overall Length L ins	Length of Thread l ins	Length of Square l 2 ins	Square A/F ins	Diameter of Shank d 1 ins
1/16	27	0.3108	0.324	2.125	0.687	0.312	0.238	0.318
1/8	27	0.4044	0.420	2.125	0.750	0.312	0.238	0.318
1/4	18	0.5343	0.559	2.437	1.062	0.437	0.322	0.429
3/8	18	0.6714	0.694	2.562	1.062	0.500	0.406	0.542
1/2	14	0.8356	0.865	3.125	1.375	0.625	0.515	0.687
3/4	14	1.0460	1.075	3.250	1.375	0.687	0.679	0.906
1	11.5	1.3082	1.350	3.750	1.750	0.812	0.843	1.125
1 1/4	11.5	1.6530	1.693	4.000	1.750	0.937	0.984	1.312
1 1/2	11.5	1.8919	1.932	4.250	1.750	1.000	1.125	1.500
2	11.5	2.3658	2.405	4.500	1.750	1.125	1.406	1.875

Straight Flute - NPT (ANSI-B.94.9)



STYLE 9



	1/16	1/8	1/4	3/8	1/2	3/4	1	1 1/4	1 1/2	2
No. of Flutes	4	4	4	4	4	5	5	5	7	7

Straight Flute - NPTF "Dryseal" (ANSI-B.94.9)



STYLE 9



	1/16	1/8	1/4	3/8	1/2	3/4	1	1 1/4
No. of Flutes	4	4	4	4	4	5	5	5

Straight Flute - NPS (ANSI-B.94.9)



STYLE 9



	1/8	1/4	3/8	1/2	3/4	1
No. of Flutes	4	4	4	4	4	6





Straight Flute - NPSF "Dryseal" (ANSI-B.94.9)



STYLE 9



	1/8	1/4	3/8	1/2	3/4	1
No. of Flutes	4	4	4	4	4	6

-  Table Reference Number
-  Metric/Imperial
-  Pitch Diameter Tolerance
-  Class of Fit
-  Available in:
Taper Lead
Second Lead
Bottom Lead

Machine Nut Tap Metric Coarse

BS949



Nominal Diameter <i>d</i> ins	Pitch	Overall Length <i>L</i> ins	Length of Thread <i>l</i> ins	Diameter of Shank <i>d</i> 1 ins	Square A/F <i>ins</i>	Length of Square <i>l</i> 2 ins
M2.5	0.45	3.25	0.625	0.072	-	-
M3	0.50	3.50	0.750	0.086	-	-
M4	0.70	4.00	1.000	0.116	0.087	0.281
M5	0.80	4.25	1.250	0.147	0.111	0.312
M6	1.00	5.00	1.625	0.182	0.133	0.562
M7	1.00	5.00	1.625	0.221	0.165	0.562
M8	1.25	5.50	1.812	0.248	0.185	0.625
M10	1.50	6.00	2.000	0.312	0.234	0.687
M12	1.75	7.00	2.500	0.377	0.282	0.875
M14	2.00	7.50	2.750	0.444	0.333	0.875
M16	2.00	8.00	3.000	0.522	0.391	0.937
M18	2.50	8.50	3.000	0.575	0.431	1.000
M20	2.50	9.00	3.250	0.654	0.490	1.000
M22	2.50	10.00	3.625	0.734	0.550	1.062
M24	3.00	10.00	3.625	0.785	0.580	1.062

Machine Nut Tap - Metric Coarse



STYLE 10



	M2.5	M3	M4	M5	M6	M7	M8	M10	M12	M14	M16	M18	M20	M22
No. of Flutes	3	3	3	3	3	3	3	3	3	3	3	3	3	3

	M24
No. of Flutes	3

Machine Nut Tap UNC

BS949



Nominal Diameter <i>d</i> ins	TPI	Overall Length <i>L</i> ins	Length of Thread <i>l</i> ins	Diameter of Shank <i>d</i> 1 ins	Square A/F <i>ins</i>	Length of Square <i>l</i> 2 ins
No. 6	32	3.75	0.750	0.090	0.070	0.250
No. 8	32	3.75	1.000	0.113	0.087	0.281
No.10	24	4.25	1.250	0.132	0.100	0.312
1/4	20	5.00	1.625	0.185	0.139	0.562
5/16	18	5.50	1.812	0.240	0.180	0.625
3/8	16	6.00	2.000	0.294	0.220	0.687
7/16	14	6.50	2.375	0.345	0.259	0.750
1/2	13	7.00	2.500	0.367	0.275	0.875
9/16	12	7.50	2.750	0.450	0.337	0.875
5/8	11	8.00	3.000	0.503	0.377	0.937
3/4	10	9.00	3.250	0.616	0.462	1.000
7/8	9	10.00	3.625	0.727	0.545	1.062
1	8	11.00	4.000	0.834	0.625	1.125

LONG REACH TAPPS

HIGH SPEED STEEL
GROUND THREAD

Machine Nut Tap - UNC



STYLE 10



CL2

TSB



	No. 6	No. 8	No. 10	1/4	5/16	3/8	7/16	1/2	9/16	5/8
No. of Flutes	3	3	3	3	3	3	3	3	3	3

	3/4	7/8	1
No. of Flutes	3	3	3

Machine Nut Tap BSW

BS949



Nominal Diameter <i>d</i> /ins	TPI	Overall Length <i>L</i> ins	Length of Thread <i>l</i> ins	Diameter of Shank <i>d</i> 1 ins	Square A/F <i>ins</i>	Length of Square <i>l</i> 2 ins
3/16	24	4.25	1.250	0.132	0.100	0.312
1/4	20	5.00	1.625	0.185	0.139	0.562
5/16	18	5.50	1.812	0.240	0.180	0.625
3/8	16	6.00	2.000	0.294	0.220	0.687
7/16	14	6.50	2.375	0.345	0.259	0.750
1/2	12	7.00	2.500	0.367	0.275	0.875
9/16	12	7.50	2.750	0.450	0.337	0.875
5/8	11	8.00	3.000	0.503	0.377	0.937
3/4	10	9.00	3.250	0.616	0.462	1.000
7/8	9	10.00	3.625	0.727	0.545	1.062
1	8	11.00	4.000	0.834	0.625	1.125

Machine Nut Tap - BSW



STYLE 10



CL2

TSB



	3/16	1/4	5/16	3/8	7/16	1/2	9/16	5/8	3/4	7/8
No. of Flutes	3	3	3	3	3	3	3	3	3	3

	1
No. of Flutes	3



Table Reference Number



Metric/Imperial



Pitch Diameter Tolerance



Class of Fit



Available in:
Taper Lead
Second Lead
Bottom Lead

Machine Nut Tap UNF

BS949



Nominal Diameter <i>d</i> ins	TPI	Overall Length <i>L</i> ins	Length of Thread <i>l</i> ins	Diameter of Shank <i>d</i> 1 ins	Square A/F <i>ins</i>	Length of Square <i>l</i> 2 ins
No. 6	40	3.75	0.750	0.090	0.070	0.250
No. 8	36	3.75	1.000	0.113	0.087	0.281
No.10	32	4.25	1.000	0.132	0.100	0.312
1/4	28	5.00	1.250	0.185	0.139	0.562
5/16	24	5.50	1.375	0.240	0.180	0.625
3/8	24	6.00	1.500	0.294	0.220	0.687
7/16	20	6.50	1.750	0.345	0.259	0.750
1/2	20	7.00	1.875	0.367	0.275	0.875
9/16	18	7.50	2.000	0.450	0.337	0.875
5/8	18	8.00	2.250	0.503	0.377	0.937
3/4	16	9.00	2.500	0.616	0.462	1.000
7/8	14	10.00	2.750	0.727	0.545	1.062
1	12	11.00	3.000	0.834	0.625	1.125

Machine Nut Tap - UNF



	No. 6	No. 8	No. 10	1/4	5/16	3/8	7/16	1/2	9/16	5/8
No. of Flutes	3	3	3	3	3	3	3	3	3	3

	3/4	7/8	1
No. of Flutes	3	3	3

Machine Nut Tap BSF

BS949



Nominal Diameter <i>d</i> ins	TPI	Overall Length <i>L</i> ins	Length of Thread <i>l</i> ins	Diameter of Shank <i>d</i> 1 ins	Square A/F <i>ins</i>	Length of Square <i>l</i> 2 ins
3/16	32	4.25	1.000	0.132	0.100	0.312
1/4	26	5.00	1.250	0.185	0.139	0.562
5/16	22	5.50	1.375	0.240	0.180	0.625
3/8	20	6.00	1.500	0.294	0.220	0.687
7/16	18	6.50	1.750	0.345	0.259	0.750
1/2	16	7.00	1.875	0.367	0.275	0.875
9/16	16	7.50	2.000	0.450	0.337	0.875
5/8	14	8.00	2.250	0.503	0.377	0.937
3/4	12	9.00	2.500	0.616	0.462	1.000
7/8	11	10.00	2.750	0.727	0.545	1.062
1	10	11.00	3.000	1.125	0.625	1.125

LONG REACH TAPPS

HIGH SPEED STEEL
GROUND THREAD

Machine Nut Tap - BSF



	3/16	1/4	5/16	3/8	7/16	1/2	9/16	5/8	3/4	7/8
No. of Flutes	3	3	3	3	3	3	3	3	3	3

	1
No. of Flutes	3

STYLE 10

Machine Nut Tap BA

BS949



Nominal Size	Thread Form	TPI	Overall Length L ins	Length of Thread l ins	Diameter of Shank d 1 ins	Square A/F ins	Length of Square l 2 ins
No. 0	BA	25.40	4.500	1.250	0.182	0.133	0.375
No. 2	BA	31.40	4.500	1.000	0.132	0.100	0.312
No. 4	BA	38.50	3.750	0.875	0.107	0.075	0.250
No. 6	BA	47.90	3.500	0.750	0.082	-	-
No. 8	BA	59.10	3.500	0.625	0.063	-	-

Machine Nut Tap - BA



	No. 0	No. 2	No. 4	No. 6	No. 8
No. of Flutes	3	3	3	3	3

STYLE 10

Machine Nut Tap BSPF For Parallel Threads

BS949



Nominal Size	Thread Form	TPI	Overall Length L ins	Length of Thread l ins	Diameter of Shank d 1 ins	Square A/F ins	Length of Square l 2 ins
1/8	BSP	28	3.75	1.000	0.318	0.238	0.562
1/4	BSP	19	5.00	1.375	0.429	0.322	0.687
3/8	BSP	19	5.00	1.375	0.542	0.406	0.750
1/2	BSP	14	7.00	2.000	0.687	0.515	0.875

Machine Nut Tap - BSPF



	1/8	1/4	3/8	1/2
No. of Flutes	3	3	3	3

1/8

1/4-1/2

STYLE 10

- Table Reference Number
- Metric/Imperial
- Pitch Diameter Tolerance
- Class of Fit
- TSB
- Available in:
Taper Lead
Second Lead
Bottom Lead

Metric Coarse

BS1127-1950

Nominal Diameter mm	Pitch mm	Outside Diameter A ins	Thickness B ins
1.6	0.35	13/16	1/4
2.0	0.40	13/16	1/4
2.2	0.45	13/16	1/4
2.5	0.45	13/16	1/4
3.0	0.50	13/16	1/4
3.5	0.60	13/16	1/4
4.0	0.70	13/16	1/4
4.5	0.75	13/16	1/4
5.0	0.80	13/16	1/4
6.0	1.00	13/16	1/4
7.0	1.00	13/16	1/4
2.0	0.40	1	3/8
3.0	0.50	1	3/8
4.0	0.70	1	3/8
5.0	0.80	1	3/8
6.0	1.00	1	3/8
7.0	1.00	1	3/8
8.0	1.25	1	3/8
9.0	1.25	1	3/8
10.0	1.50	1	3/8
6.0	1.00	1 5/16	7/16
7.0	1.00	1 5/16	7/16
8.0	1.25	1 5/16	7/16
9.0	1.25	1 5/16	7/16
10.0	1.50	1 5/16	7/16
11.0	1.50	1 5/16	7/16
12.0	1.75	1 5/16	7/16
14.0	2.00	1 5/16	7/16
8.0	1.25	1 1/2	1/2
10.0	1.50	1 1/2	1/2
11.0	1.50	1 1/2	1/2
12.0	1.75	1 1/2	1/2
14.0	2.00	1 1/2	1/2
16.0	2.00	1 1/2	1/2
18.0	2.50	1 1/2	1/2
20.0	2.50	1 1/2	1/2
12.0	1.75	2	5/8
14.0	2.00	2	5/8
16.0	2.00	2	5/8
18.0	2.50	2	5/8
20.0	2.50	2	5/8

Metric Coarse

Nominal Diameter mm	Pitch mm	Outside Diameter A ins	Thickness B ins
22.0	2.50	2	5/8
24.0	3.00	2	5/8
14.0	2.00	2 1/4	11/16
16.0	2.00	2 1/4	11/16
18.0	2.50	2 1/4	11/16
20.0	2.50	2 1/4	11/16
22.0	2.50	2 1/4	11/16
24.0	3.00	2 1/4	11/16
27.0	3.00	2 1/4	11/16
24.0	3.00	3	7/8
27.0	3.00	3	7/8
30.0	3.50	3	7/8
33.0	3.50	3	7/8
36.0	4.00	3	7/8
39.0	4.00	3	7/8

Metric Coarse - Left Hand

BS1127-1950

Nominal Diameter mm	Pitch mm	Outside Diameter A ins	Thickness B ins
3	0.50	13/16	1/4
4	0.70	13/16	1/4
5	0.80	13/16	1/4
6	1.00	1	3/8
8	1.25	1	3/8
10	1.50	1	3/8
10	1.50	1 5/16	7/16
12	1.75	1 5/16	7/16
12	1.75	1 1/2	1/2
14	2.00	1 1/2	1/2
16	2.00	1 1/2	1/2
18	2.50	2	5/8
20	2.50	2	5/8

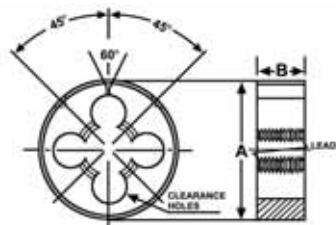

Metric Fine

BS1127-1950

Nominal Diameter mm	Pitch mm	Outside Diameter A ins	Thickness B ins
3.0	0.35	13/16	1/4
3.5	0.35	13/16	1/4
4.0	0.50	13/16	1/4
4.5	0.50	13/16	1/4
5.0	0.50	13/16	1/4
6.0	0.75	13/16	1/4
7.0	0.75	13/16	1/4
7.0	0.75	1	3/8
8.0	1.00	1	3/8
10.0	1.00	1	3/8
10.0	1.25	1	3/8
12.0	1.00	1 5/16	7/16
12.0	1.25	1 5/16	7/16
12.0	1.50	1 5/16	7/16
14.0	1.25	1 5/16	7/16
14.0	1.50	1 5/16	7/16
14.0	1.50	1 1/2	1/2
16.0	1.50	1 1/2	1/2
18.0	1.50	1 1/2	1/2
20.0	1.50	2	5/8
22.0	1.50	2	5/8
24.0	1.50	2	5/8
24.0	2.00	2	5/8
25.0	1.50	2	5/8
27.0	2.00	3	7/8
30.0	2.00	3	7/8

UNC

BS1127-1950

Nominal Diameter ins	Threads per inch	Outside Diameter A ins	Thickness B ins
No.1	64	13/16	1/4
No.2	56	13/16	1/4
No.3	48	13/16	1/4
No.4	40	13/16	1/4
No.5	40	13/16	1/4
No.6	32	13/16	1/4
No.8	32	13/16	1/4
No.10	24	13/16	1/4
No.12	24	13/16	1/4
1/4	20	13/16	1/4
No.8	32	1	3/8
No.10	24	1	3/8
No.12	24	1	3/8
1/4	20	1	3/8

UNC

Nominal Diameter ins	Threads per inch	Outside Diameter A ins	Thickness B ins
5/16	18	1	3/8
3/8	16	1	3/8
1/4	20	1 5/16	7/16
5/16	18	1 5/16	7/16
3/8	16	1 5/16	7/16
7/16	14	1 5/16	7/16
1/2	13	1 5/16	7/16
9/16	12	1 5/16	7/16
1/4	20	1 1/2	1/2
5/16	18	1 1/2	1/2
3/8	16	1 1/2	1/2
7/16	14	1 1/2	1/2
1/2	13	1 1/2	1/2
9/16	12	1 1/2	1/2
5/8	11	1 1/2	1/2
3/4	10	1 1/2	1/2
1/2	13	2	5/8
9/16	12	2	5/8
5/8	11	2	5/8
3/4	10	2	5/8
7/8	9	2	5/8
1	8	2	5/8
9/16	12	2 1/4	11/16
5/8	11	2 1/4	11/16
3/4	10	2 1/4	11/16
7/8	9	2 1/4	11/16
1	8	2 1/4	11/16
1 1/8	7	2 1/4	11/16
1	8	3	7/8
1 1/8	7	3	7/8
1 1/4	7	3	7/8
1 3/8	6	3	7/8
1 1/2	6	3	7/8

UNC - Left Hand

BS1127-1950

Nominal Diameter ins	Threads per inch	Outside Diameter A ins	Thickness B ins
1/4	20	13/16	1/4
1/4	20	1	3/8
5/16	18	1	3/8
3/8	16	1	3/8
1/2	13	1 5/16	7/16
3/8	16	1 1/2	1/2
1/2	13	1 1/2	1/2
5/8	11	1 1/2	1/2
3/4	10	2	5/8

UNF

BS1127-1950

Nominal Diameter <i>ins</i>	Threads per inch	Outside Diameter A <i>ins</i>	Thickness B <i>ins</i>
No.0	80	13/16	1/4
No.1	72	13/16	1/4
No.2	64	13/16	1/4
No.3	56	13/16	1/4
No.4	48	13/16	1/4
No.5	44	13/16	1/4
No.6	40	13/16	1/4
No.8	36	13/16	1/4
No.10	32	13/16	1/4
No.12	28	13/16	1/4
1/4	28	13/16	1/4
1/4	28	1	3/8
5/16	24	1	3/8
3/8	24	1	3/8
1/4	28	1 5/16	7/16
5/16	24	1 5/16	7/16
3/8	24	1 5/16	7/16
7/16	20	1 5/16	7/16
1/2	20	1 5/16	7/16
9/16	18	1 5/16	7/16
3/8	24	1 1/2	1/2
7/16	20	1 1/2	1/2
1/2	20	1 1/2	1/2
9/16	18	1 1/2	1/2
5/8	18	1 1/2	1/2
3/4	16	1 1/2	1/2
1/2	20	2	5/8
9/16	18	2	5/8
5/8	18	2	5/8
3/4	16	2	5/8
7/8	14	2	5/8
1	12	2	5/8
9/16	18	2 1/4	11/16
5/8	18	2 1/4	11/16
3/4	16	2 1/4	11/16
7/8	14	2 1/4	11/16
1	12	2 1/4	11/16

UNF

Nominal Diameter <i>ins</i>	Threads per inch	Outside Diameter A <i>ins</i>	Thickness B <i>ins</i>
1 1/8	12	2 1/4	11/16
1	12	3	7/8
1 1/8	12	3	7/8
1 1/4	12	3	7/8
1 3/8	12	3	7/8
1 1/2	12	3	7/8

UNF - Left Hand

BS1127-1950

Nominal Diameter <i>ins</i>	Threads per inch	Outside Diameter A <i>ins</i>	Thickness B <i>ins</i>
1/4	28	13/16	1/4
1/4	28	1	3/8
5/16	24	1	3/8
3/8	24	1	3/8
1/2	20	1 5/16	7/16
3/8	24	1 1/2	1/2
1/2	20	1 1/2	1/2
5/8	18	1 1/2	1/2
3/4	16	2	5/8

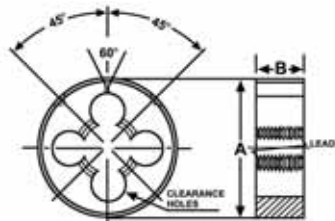

BSW

BS1127-1950

Nominal Diameter <i>ins</i>	Threads per inch	Outside Diameter <i>A ins</i>	Thickness <i>B ins</i>
1/16	60	13/16	1/4
3/32	48	13/16	1/4
1/8	40	13/16	1/4
5/32	32	13/16	1/4
3/16	24	13/16	1/4
7/32	24	13/16	1/4
1/4	20	13/16	1/4
1/4	20	1	3/8
5/16	18	1	3/8
3/8	16	1	3/8
1/4	20	1 5/16	7/16
5/16	18	1 5/16	7/16
3/8	16	1 5/16	7/16
7/16	14	1 5/16	7/16
1/2	12	1 5/16	7/16
9/16	12	1 5/16	7/16
3/8	16	1 1/2	1/2
7/16	14	1 1/2	1/2
1/2	12	1 1/2	1/2
9/16	12	1 1/2	1/2
5/8	11	1 1/2	1/2
3/4	10	1 1/2	1/2
1/2	12	2	5/8
9/16	12	2	5/8
5/8	11	2	5/8
3/4	10	2	5/8
7/8	9	2	5/8
1	8	2	5/8
9/16	12	2 1/4	11/16
5/8	11	2 1/4	11/16
3/4	10	2 1/4	11/16
7/8	9	2 1/4	11/16
1	8	2 1/4	11/16
1 1/8	7	2 1/4	11/16
1	8	3	7/8
1 1/8	7	3	7/8
1 1/4	7	3	7/8
1 3/8	6	3	7/8
1 1/2	6	3	7/8

BSW - Left Hand

BS1127-1950

Nominal Diameter <i>ins</i>	Threads per inch	Outside Diameter <i>A ins</i>	Thickness <i>B ins</i>
1/4	20	13/16	1/4
1/4	20	1	3/8
5/16	18	1	3/8
3/8	16	1	3/8
5/16	18	1 5/16	7/16
3/8	16	1 5/16	7/16
1/2	12	1 5/16	7/16
3/8	16	1 1/2	1/2
1/2	12	2	1/2
5/8	11	1 1/2	1/2
5/8	11	2	5/8
3/4	10	2	5/8

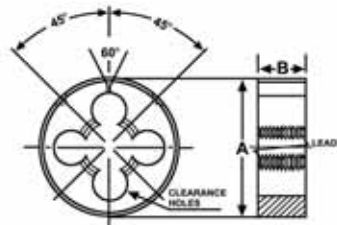

BSF

BS1127-1950

Nominal Diameter <i>ins</i>	Threads per inch	Outside Diameter A <i>ins</i>	Thickness B <i>ins</i>
3/16	32	13/16	1/4
1/4	26	13/16	1/4
1/4	26	1	3/8
5/16	22	1	3/8
3/8	20	1	3/8
1/4	26	1 5/16	7/16
5/16	22	1 5/16	7/16
3/8	20	1 5/16	7/16
7/16	18	1 5/16	7/16
1/2	16	1 5/16	7/16
9/16	16	1 5/16	7/16
3/8	20	1 1/2	1/2
7/16	18	1 1/2	1/2
1/2	16	1 1/2	1/2
9/16	16	1 1/2	1/2
5/8	14	1 1/2	1/2
1/2	16	2	5/8
9/16	16	2	5/8
5/8	14	2	5/8
3/4	12	2	5/8
7/8	11	2	5/8
1	10	2	5/8
9/16	16	2 1/4	11/16
5/8	14	2 1/4	11/16
3/4	12	2 1/4	11/16
7/8	11	2 1/4	11/16
1	10	2 1/4	11/16
1 1/8	9	2 1/4	11/16
1	10	3	7/8
1 1/8	9	3	7/8
1 1/4	9	3	7/8
1 3/8	8	3	7/8
1 1/2	8	3	7/8

BSF - Left Hand

BS1127-1950

Nominal Diameter <i>ins</i>	Threads per inch	Outside Diameter A <i>ins</i>	Thickness B <i>ins</i>
1/4	26	13/16	1/4
1/4	26	1	3/8
5/16	22	1	3/8
3/8	20	1	3/8
5/16	22	1 5/16	7/16
3/8	20	1 5/16	7/16
1/2	16	1 5/16	7/16
1/2	16	1 1/2	1/2
5/8	14	1 1/2	1/2

BA

BS1127-1950

Nominal Size BA	Threads per inch	Outside Diameter A <i>ins</i>	Thickness B <i>ins</i>
0	25.4	13/16	1/4
1	28.2	13/16	1/4
2	31.4	13/16	1/4
3	34.8	13/16	1/4
4	38.5	13/16	1/4
5	43	13/16	1/4
6	47.9	13/16	1/4
7	52.9	13/16	1/4
8	59.1	13/16	1/4
0	25.4	1	3/8
1	28.2	1	3/8
2	31.4	1	3/8

BA - Left Hand

BS1127-1950

Nominal Size BA	Threads per inch	Outside Diameter A <i>ins</i>	Thickness B <i>ins</i>
0	25.4	13/16	1/4
2	31.4	13/16	1/4
4	38.5	13/16	1/4

NPT

BS1127-1950

Nominal Diameter <i>ins</i>	Threads per inch	Outside Diameter A <i>ins</i>	Thickness B <i>ins</i>
1/8	27	1	3/8
1/8	27	1 5/16	7/16
1/4	18	1 5/16	7/16
1/8	27	1 1/2	1/2
1/4	18	1 1/2	1/2
3/8	18	1 1/2	1/2
1/4	18	2	5/8
3/8	18	2	5/8
1/2	14	2	5/8
3/4	14	2	5/8
3/8	18	2 1/4	11/16
1/2	14	2 1/4	11/16
3/4	14	2 1/4	11/16
1	11.5	2 1/4	11/16
1	11.5	3	7/8
1 1/4	11.5	3	7/8

BSB - (British Standard Brass)

BS1127-1950

Nominal Diameter <i>ins</i>	Threads per inch	Outside Diameter A <i>ins</i>	Thickness B <i>ins</i>
1/4	26	13/16	1/4
5/16	26	1	3/8
3/8	26	1	3/8
7/16	26	1 5/16	7/16
1/2	26	1 5/16	7/16
5/8	26	1 1/2	1/2
3/4	26	1 1/2	1/2

BSPT

BS1127-1950

Nominal Diameter <i>ins</i>	Threads per inch	Outside Diameter A <i>ins</i>	Thickness B <i>ins</i>
1/8	28	1	3/8
1/8	28	1 5/16	7/16
1/4	19	1 5/16	7/16
1/8	28	1 1/2	1/2
1/4	19	1 1/2	1/2
3/8	19	1 1/2	1/2
1/4	19	2	5/8
3/8	19	2	5/8
1/2	14	2	5/8
3/4	14	2	5/8
3/8	19	2 1/4	11/16
1/2	14	2 1/4	11/16
3/4	14	2 1/4	11/16
1	11	2 1/4	11/16
3/4	14	3	7/8
1	11	3	7/8
1 1/4	11	3	7/8

BSPF

BS1127-1950

Nominal Diameter <i>ins</i>	Threads per inch	Outside Diameter A <i>ins</i>	Thickness B <i>ins</i>
1/8	28	1	3/8
1/8	28	1 5/16	7/16
1/4	19	1 5/16	7/16
1/8	28	1 1/2	1/2
1/4	19	1 1/2	1/2
3/8	19	1 1/2	1/2
1/2	14	1 1/2	1/2
1/4	19	2	5/8
3/8	19	2	5/8
1/2	14	2	5/8
5/8	14	2	5/8
3/4	14	2	5/8
3/8	19	2 1/4	11/16
1/2	14	2 1/4	11/16
5/8	14	2 1/4	11/16
3/4	14	2 1/4	11/16
7/8	14	2 1/4	11/16
1	11	2 1/4	11/16
3/4	14	3	7/8
7/8	14	3	7/8
1	11	3	7/8
1 1/4	11	3	7/8

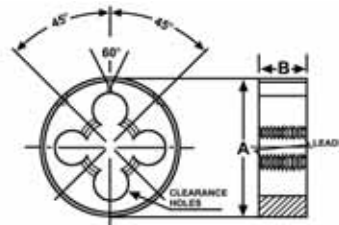

Metric Coarse

BS1127-1950

Nominal Diameter <i>mm</i>	Pitch <i>mm</i>	Across Flats <i>A ins</i>	Thickness <i>B ins</i>
3	0.5	0.71	1/4
4	0.7	0.71	1/4
5	0.8	0.71	1/4
6	1	0.71	1/4
7	1	0.82	5/16
8	1.25	0.82	5/16
9	1.25	0.92	3/8
10	1.5	0.92	3/8
11	1.5	1.01	7/16
12	1.75	1.1	1/2
14	2	1.3	5/8
16	2	1.3	5/8
18	2.5	1.48	11/16
20	2.5	1.48	11/16
22	2.5	1.67	13/16
24	3	2.05	15/16

Metric Fine

BS1127-1950

Nominal Diameter <i>mm</i>	Pitch <i>mm</i>	Across Flats <i>A ins</i>	Thickness <i>B ins</i>
3	0.35	0.71	1/4
4	0.50	0.71	1/4
4.5	0.50	0.71	1/4
5	0.50	0.71	1/4
6	0.75	0.71	1/4
7	0.75	0.82	5/16
8	1.00	0.82	5/16
10	1.00	0.92	3/8
10	1.25	0.92	3/8
12	1.25	1.10	1/2
12	1.50	1.10	1/2
14	1.25	1.30	5/8
14	1.50	1.30	5/8
16	1.50	1.30	5/8
18	1.50	1.48	11/16
20	1.50	1.48	11/16
22	1.50	1.67	13/16
24	1.50	2.05	15/16
24	2.00	2.05	15/16
25	1.50	2.05	15/16
30	2.00	2.22	1 1/16
32	1.50	2.58	1 1/8

UNF

BS1127-1950

Nominal Diameter <i>ins</i>	Threads per inch	Across Flats <i>A ins</i>	Thickness <i>B ins</i>
No.10	32	0.71	1/4
1/4	28	0.71	1/4
5/16	24	0.82	5/16
3/8	24	0.92	3/8
7/16	20	1.01	7/16
1/2	20	1.10	1/2
9/16	18	1.30	5/8
5/8	18	1.30	5/8
3/4	16	1.48	11/16
7/8	14	1.67	13/16
1	12	2.05	15/16
1 1/8	12	2.22	1 1/16
1 1/4	12	2.20	1 1/16
1 1/2	12	2.76	1 1/4

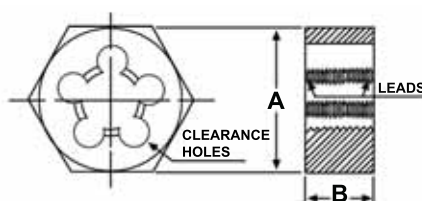

UNC

BS1127-1950

Nominal Diameter <i>ins</i>	Threads per inch	Across Flats A <i>ins</i>	Thickness B <i>ins</i>
No. 8	32	0.71	1/4
No.10	24	0.71	1/4
No.12	24	0.71	1/4
1/4	20	0.71	1/4
5/16	18	0.82	5/16
3/8	16	0.92	3/8
7/16	14	1.01	7/16
1/2	13	1.1	1/2
9/16	12	1.3	5/8
5/8	11	1.3	5/8
3/4	10	1.48	11/16
7/8	9	1.67	13/16
1	8	2.05	15/16
1 1/8	7	2.22	1 1/16
1 1/4	7	2.22	1 1/16
1 1/2	6	2.76	1 1/4
2	4.5	3.55	1 3/4

BSW

BS1127-1950

Nominal Diameter <i>ins</i>	Threads per inch	Across Flats A <i>ins</i>	Thickness B <i>ins</i>
1/8	40	0.71	1/4
3/16	24	0.71	1/4
1/4	20	0.71	1/4
5/16	18	0.82	5/16
3/8	16	0.92	3/8
7/16	14	1.01	7/16
1/2	12	1.1	1/2
9/16	12	1.3	5/8
5/8	11	1.3	5/8
3/4	10	1.48	11/16
7/8	9	1.67	13/16
1	8	2.05	15/16
1 1/8	7	2.22	1 1/16
1 1/4	7	2.22	1 1/16
1 1/2	6	2.76	1 1/4
2	4.5	3.55	1 3/4

BA

BS1127-1950

Nominal Size BA	Threads per inch	Across Flats A <i>ins</i>	Thickness B <i>ins</i>
0BA	1.00	0.71	1/4
2BA	0.81	0.71	1/4
4BA	0.66	0.71	1/4
6BA	0.53	0.71	1/4

BSF

BS1127-1950

Nominal Diameter <i>ins</i>	Pitch <i>mm</i>	Across Flats A <i>ins</i>	Thickness B <i>ins</i>
3/16	32	0.71	1/4
1/4	26	0.71	1/4
5/16	22	0.82	5/16
3/8	20	0.92	3/8
7/16	18	1.01	7/16
1/2	16	1.1	1/2
9/16	16	1.3	5/8
5/8	14	1.3	5/8
3/4	12	1.48	11/16
7/8	11	1.67	13/16
1	10	2.05	15/16
1 1/8	9	2.22	1 1/16
1 1/4	9	2.22	1 1/16
1 1/2	8	2.76	1 1/4

BSPF

BS1127-1950

Nominal Diameter <i>ins</i>	Threads per inch	Across Flats A <i>ins</i>	Thickness B <i>ins</i>
1/8	28	0.92	3/8
1/4	19	1.10	1/2
3/8	19	1.30	5/8
1/2	14	1.67	13/16
5/8	14	1.67	13/16
3/4	14	2.05	15/16
1	11	2.58	1 1/8

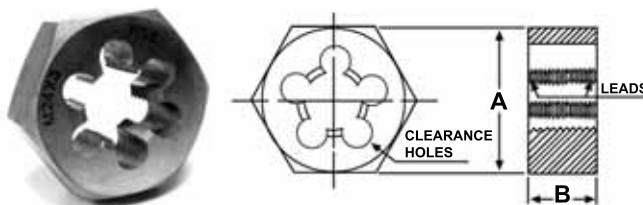

Adjustable Tap Wrenches



GOL No. 0	M1 – M8 or $\frac{1}{16}$ " – $\frac{1}{4}$ "
GOL No. 1	M1 – M10 or $\frac{1}{16}$ " – $\frac{3}{8}$ "
GOL No. 2	M3.5 – M12 or $\frac{5}{32}$ " – $\frac{1}{2}$ "
GOL No. 3	M5 – M20 or $\frac{7}{32}$ " – $\frac{3}{4}$ "
GOL No. 4	M9 – M27 or $\frac{7}{16}$ " – 1"
GOL No. 5	M13 – 32 or $\frac{1}{2}$ " – $1\frac{1}{4}$ "
GOL No. 6	M18 – 42 or $\frac{3}{4}$ " – $1\frac{1}{2}$ "
GOL No. 7	M25 – M50 or 1" – $2\frac{1}{8}$ "

Tee Bar Wrenches (Ratchet Type)

No. 1 Ratchet	M3 – M10 or $\frac{1}{8}$ " – $\frac{3}{8}$ "
No. 2 Ratchet	M5 – M12 or $\frac{7}{32}$ " – $\frac{1}{2}$ "

Tee Bar Wrenches (Fixed Type)

No. 1a Fixed	M3 – M8 or $\frac{1}{16}$ " – $\frac{5}{16}$ "
No. 2a Fixed	M5 – M10 or $\frac{5}{32}$ " – $\frac{3}{8}$ "
No. 3a Fixed	M6 – M12 or $\frac{1}{4}$ " – $\frac{1}{2}$ "



Die Stocks



To suit dies:	$\frac{13}{16}$ " O/D x $\frac{1}{4}$ " thick
	1" O/D x $\frac{3}{8}$ " thick
	$1\frac{5}{6}$ " O/D x $\frac{7}{16}$ " thick
	$1\frac{1}{2}$ " O/D x $\frac{1}{2}$ " thick
	2" O/D x $\frac{5}{8}$ " thick
	$2\frac{1}{4}$ " O/D x $\frac{11}{16}$ " thick
	3" O/D x $\frac{7}{8}$ " thick
	4" O/D x 1" thick

Threading Tool Kits

HIGH SPEED STEEL GROUND THREAD

Goliath offer a comprehensive selection of H.S.S. Threading Tool Kits including Taps and Dies, Tapwrenches and Circular Diestocks conveniently presented in a sturdy wooden case. They are available in **Metric Coarse**, **Metric Fine**, **UNC**, **UNF**, **BSW**, **BSF** and **BA** and in a wide variety of sizes to cover all applications.



Special boxed sets can be made up to individual requirements.



Tap Index Sets

HIGH SPEED STEEL GROUND THREAD

Available in **Metric**, **UNC**, **UNF**, **BSW** and **BSF**. Spiral Point & Spiral Flute Tap Sets can also be supplied. Hand/Short Machine Taps in sets of three all Straight Flute.

Tap and Drill Sets

HIGH SPEED STEEL GROUND THREAD

Available in **Metric** only. Spiral Point / Spiral Flute, Straight Flute, Combinations Available.



CASED SETS



Tap & Die Set

Contains taper and bottom Straight Flute Taps and Circular Dies in sizes **M3-M10** plus Tap Wrench and Die Stock to suit.



Handy Six

Six HSS Taps

Metric tap combinations available.
Straight Flute Taps available in any lead.
M3-M10 or M4-M12.

Handy Six

Six HSS Circular Dies or Dienuts

6 piece set available in **Metric, UNC, UNF, BSF, BSW** and **BA.**



Handy Seven

Seven HSS Taps

7 Piece Metric Set.
M3-M12.

Fastener Taps

Goliath also specialises in the manufacture of threading tools used in the fastener industry.

Taps are produced to suit all known makes of nut tapping machines, backed by extensive stocks of the many sizes of threads and pitches needed by industry today.

Goliath can offer Bent Shank Taps or, Nibs only. **Goliath** offers three types of Nibs for:

- Butt Welding
- Soldering
- Coupling

We can also provide Straight Taps suitable for bending to customer requirements. Whatever the type of machine, for quality fastener production, **Goliath** has a solution.



Solder Nib Tap



Bent Shank Tap

Surface treated taps are available in various coatings to offer superior tool life and reliability.

Wire Thread Insert Taps

Goliath also manufactures a range of wire thread insert taps available for contracts. These are available from **Goliath** in **Metric** and all other thread forms in a range of sizes.



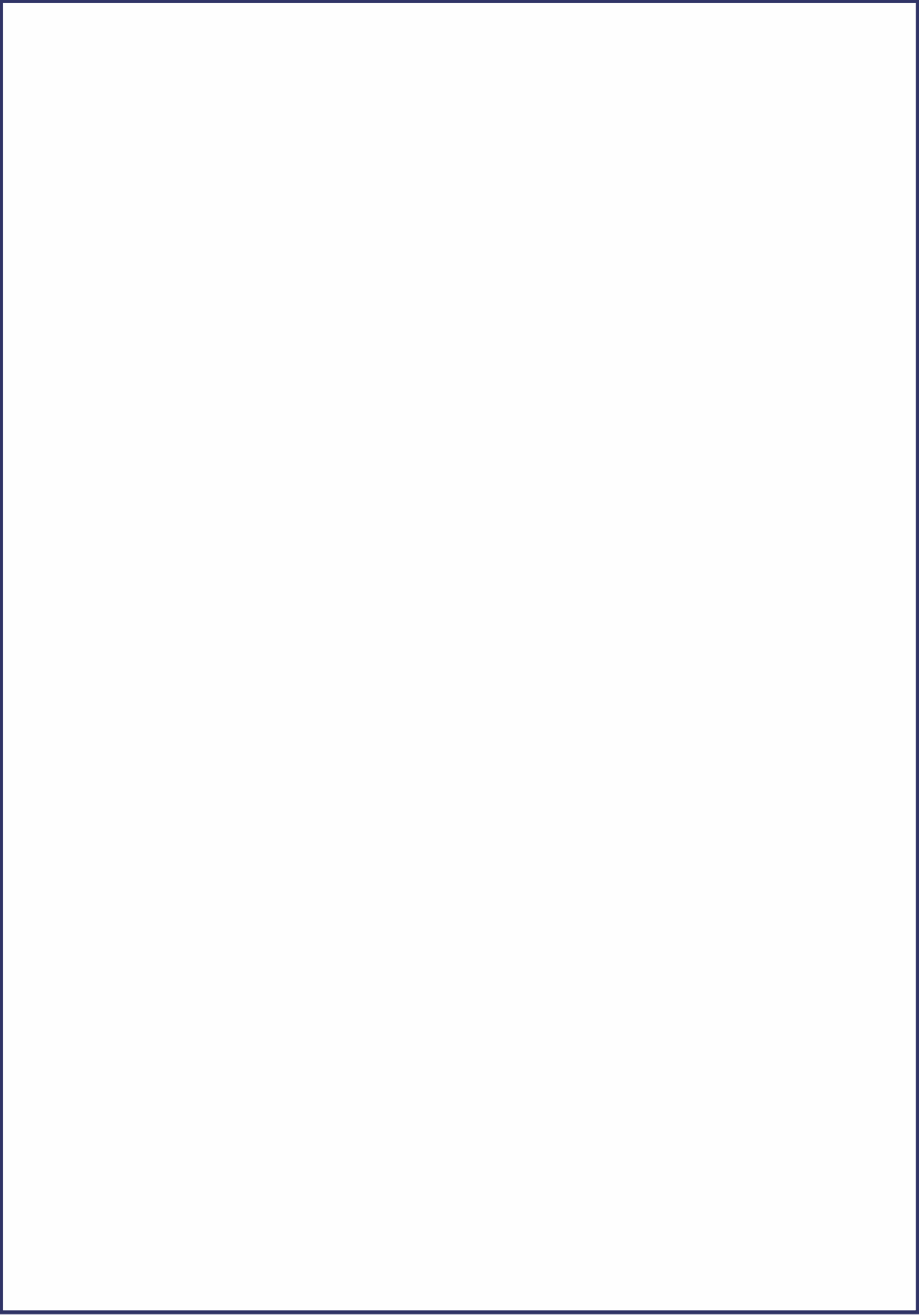

Main Types of Taps

HAND TAPS

Straight Flute

This regular type is the basic tap designed as a general purpose tool for hand and machine operations.

As this basic tap will give acceptable performance in most materials and for short production runs, it is usually the most economical tap to use. However, it performs best in materials where the cutting action results in chips, which break up readily and do not present problems of chip disposal.

These taps may not be suitable because of inadequate chip space when deep or blind holes have to be tapped in soft stringy materials. This applies particularly to the coarser pitch threads such as BSW and UNC.

Straight Flute Taps are available in **Taper**, **Second** and **Bottom** Lead.

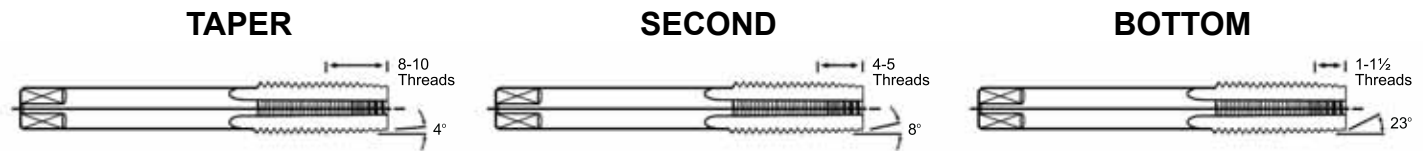

Please note in America Second Lead is commonly known as Plug Lead.
In Australia Second Lead is known as Intermediate Lead (Inter).

MACHINE TAPS

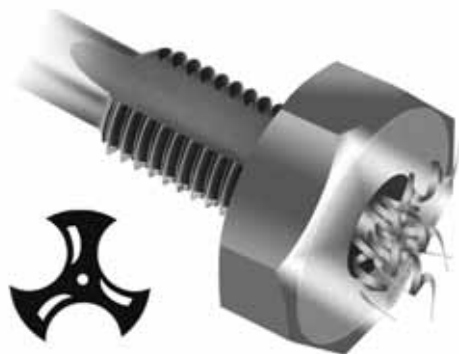

Spiral Point

Gun nose taps have straight flutes supplemented by angular cutting faces at the lead. The design of the cutting portion propels the swarf ahead of the tap leaving the flutes clear for the flow of coolant to the cutting teeth.

Primarily designed for use in through holes, these taps can be used in blind holes provided that there is ample clearance beyond the threaded section to accommodate the swarf. The advantages of a gun nose tap are, the shearing action of the angular cutting faces which produce a fine finish on the threads and shallower flutes which permit a stronger cross section throughout the tap.

Spiral Flute

These taps, designed primarily for machine tapping of blind holes, are used to the best advantage in materials that produce long continuous chips. The right hand spiral forces the swarf out of the hole and prevents the chips from clogging at the bottom of the hole or in the flutes, which could cause tap breakage or spoiled threads.



Main Types of Taps

PIPE TAPS

Pipe Taps are supplied with **PARALLEL** threads or **TAPER** threads.

These taps are shorter than a similar size of regular hand tap but the design features are the same. They are suitable for hand or machine use.

Parallel Pipe Taps

Parallel pipe taps are used for parallel threading by hand or machine.

- 1. BSP – “G” Series (made to British Standards):** Used when a pressure tight joint on the threads is not required (note: a sealant must be used)
- 2. NPS (made to American Standards):** Used for free-fitting mechanical joints where thread sealing is not required.

Tapered Pipe Taps

Tapered pipe taps are used for tapered threading by hand or machine.

- 1. BSPT – “Rc” Series (made to British Standards):** Used when a pressure joint on threads is required. (note: a sealant must be used).
- 2. NPT (made to American Standards):** Used when a general purpose fit is required.

FLUTELESS TAPS

These taps are designed for machine tapping in ductile materials, Fluteless taps have no flutes or cutting edges, but have special roll forming lobes with circular lands.

The Advantages of Fluteless Tapping are:

- 1. Elimination of Tap Breakages:** There are no chips to cause jamming or cutting edges to grow dull or breakdown.
- 2. The Fluteless Design:** Produces threads with unbroken metal grain fibres. The threads are therefore stronger.
- 3. Better control of Tapping Hole Sizes:** Fluteless taps cannot be forced into lead-error or go oversize when changes occur in machine or operator’s pressure. The clamping of the work piece is important as the method of forming threaded holes compared with conventional tapping creates additional torque of up to 50%.
- 4. Blind Hole Tapping:** No chips to cause interference at the bottom of the hole. In plating operations there are no chips to cause rejects.
- 5. Longer Tap Life:** The Fluteless tap is substantially stronger than a conventional tap; hence there is longer tool life.
- 6. Faster Tapping Speeds:** Produce more tapped pieces per hour.



Surface Treatment

Surface Treatments Carried Out On Goliath High Speed Steel Taps

Of the various treatments, the three processes most generally used to improve the surface properties of taps are as follows:

1. NITRIDING

2. STEAM TEMPERING

3. TITANIUM NITRIDE COATING

OTHER TREATMENTS ARE ALSO AVAILABLE - ASK FOR DETAILS

NITRIDING

Nitriding as applied to High Speed Steel is for the purpose of increasing tool life by producing a very hard skin or case. The elementary theory of the process is that under the action of heat, liberated Nitrogen diffuses into the surfaces of the tap forming alloy nitrides. The depth of the case and also the subsequent hardness is related to the time of the treatment.

The obvious advantages of nitriding can be easily seen when tapping abrasive materials such as cast iron, plastic and bakelite. The extreme hardness of the surface of the tap, baked up by the material hardness in the range of VH 820-870 is very resistant to abrasion. This gives a greatly prolonged useful life.

The advantage of nitriding can be related to certain trials carried out on cylinder blocks in the motor industry where short life was being obtained from standard heat treated taps due to the abrasive properties of the cast iron. On examination of the taps after use no real visual damage was apparent, but micrometer inspection revealed that the tap had been worn undersize. When nitrided taps were applied to the same operation tool life was increased between 50% to 80%. Although great advantages can be obtained when nitrided taps are used on cast iron, they are not generally for use on steel. However, certain selected applications on steel have proved successful after trials carried out in conjunction with users.

STEAM TEMPERING – BLUE FINISH



The taps are treated at about 500°C in a furnace containing a steam atmosphere. This steam atmosphere causes an oxide layer to be formed on the surface of the taps giving a blue appearance. This layer can be classified as porous so that when a tap is immersed in a lubricant a certain amount is drawn into the layer and remains there during tapping operations. This ensures that in normal operating conditions no dry-cutting occurs even in operations where it is difficult to maintain the constant lubricated feed.

Unlike nitriding there is no increase in surface hardness but an increase in life can be expected due to lubrication being maintained at the cutting edge, so reducing frictional effects.

TITANIUM NITRIDE COATING (TIN) – GOLD FINISH

TiN coating is a very hard, gold coloured coating a few microns thick which is applied by means of a complex process, called Physical Vapour Deposition (PVD), by advanced modern equipment. The coating is non-metallic and therefore reduces cold welding.

In certain applications increased speed and feed rates can be achieved because of the hardness of the coating and the reduction in cutting force required to a decrease in friction between the tool and the work piece.

Tool performance will deteriorate after re-sharpening.

Tap Nomenclature

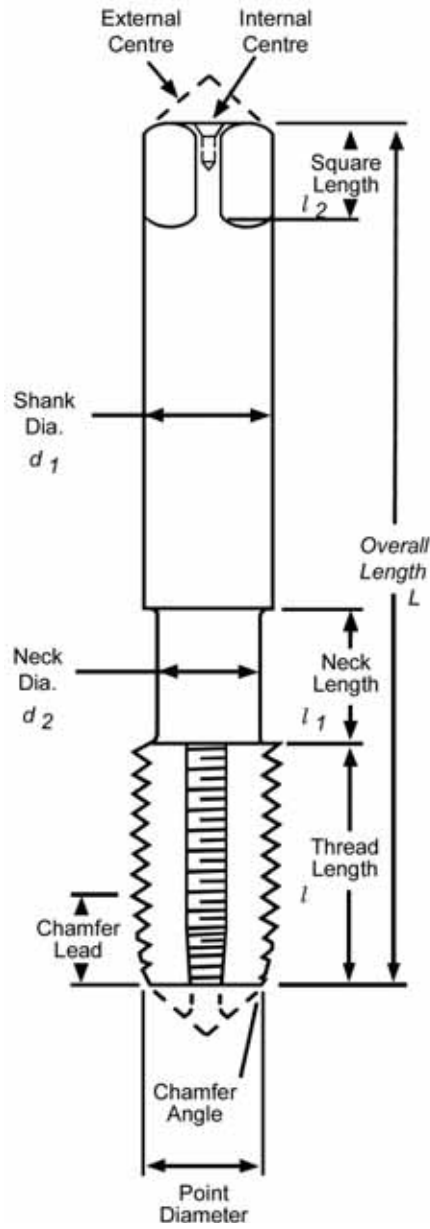
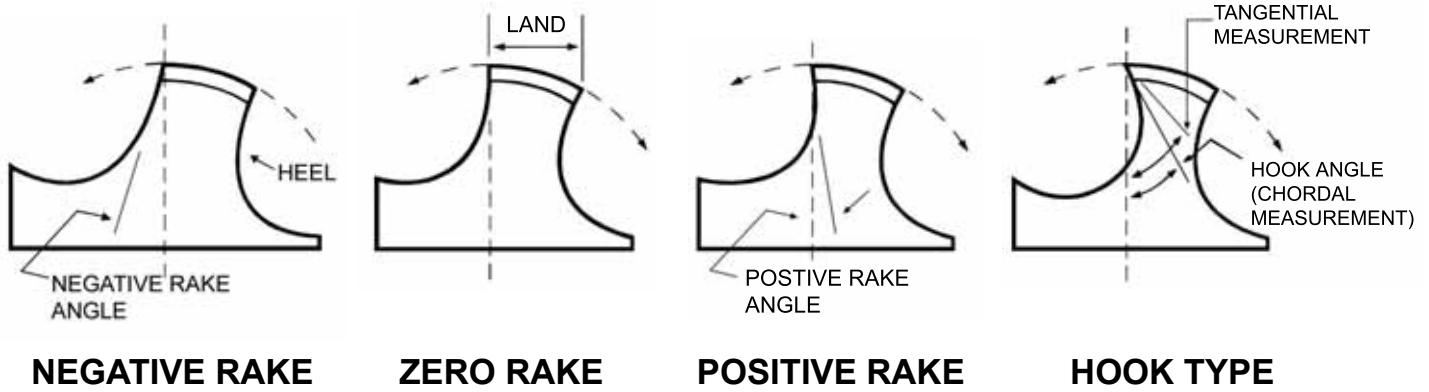

SIZE OF SQUARE ACROSS FLATS

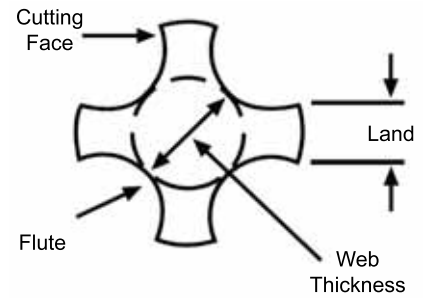
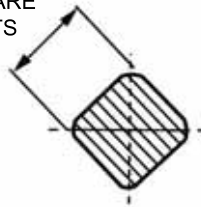

Die Nomenclature

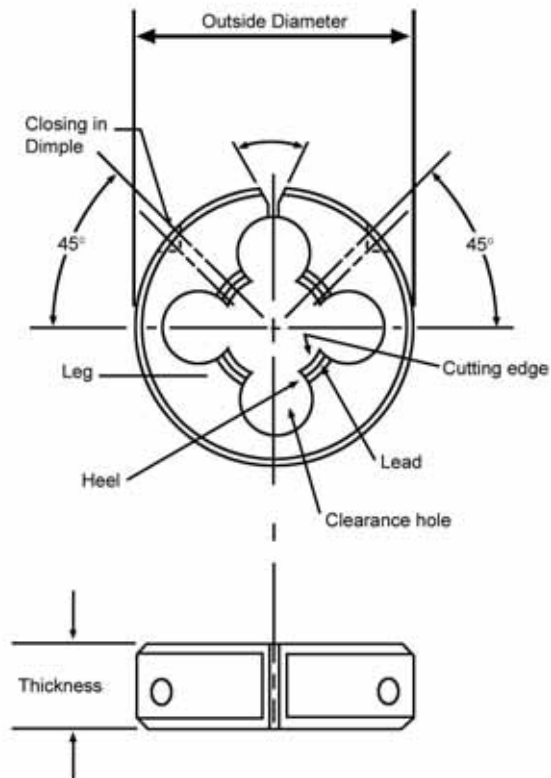

Basic Profiles

FOR ISO INCH (UNIFIED) AND ISO METRIC

The basic form is derived from an equilateral triangle which is truncated $\frac{1}{8}$ of the height at the major diameter and $\frac{1}{4}$ of the height at the minor diameter. The corresponding flats have a width of $\frac{P}{8}$ and $\frac{P}{4}$ respectively. See Fig 1.

In practice, clearance is provided beyond the $\frac{P}{8}$ flat on internal threads and beyond the $\frac{p}{4}$ flat on external threads. These clearances are usually rounded.

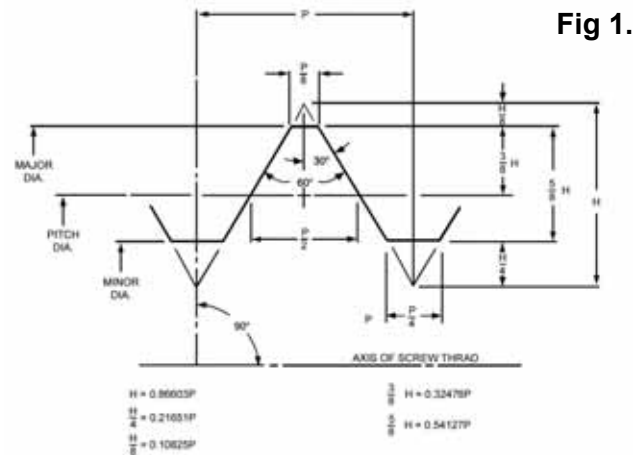

ISO METRIC Tolerance positions

Three tolerance positions are standardised for bolts and two for nuts. These are designed e, g and h for bolts and G and H for nuts. As in the I.S.O. System for limits and fits, small letters used to designate tolerance positions for bolts and capital letters are used for nut tolerance positions. Also the letters h and H are used for tolerance positions having the maximum metal limit coincided with the basic size, i.e., with a fundamental deviation of zero. See Fig 2.

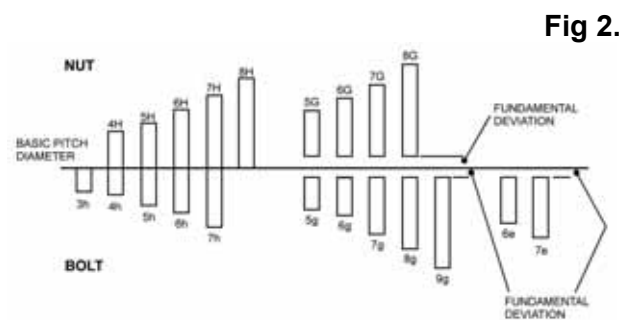

ISO METRIC Tolerance grades

A series of tolerance grades designated 4, 5, 6, 7 and 8, for nut pitch diameters. An extended series of tolerance grades, designated 3, 4, 5, 6, 7, 8 and 9, for bolt pitch diameters.

An important factor here is that for the same tolerance grade the nut pitch diameter tolerance is 1.32 x the corresponding bolt pitch diameter tolerance.

FOR WHITWORTH (BSW, BSF, BSPF) THREAD FORMS

Thread form = 55°

Top and bottom are truncated one sixth of the height.

The depth of thread is two thirds of triangular height, which equals 0.6403 pitch.

Crests and roots are rounded as shown.

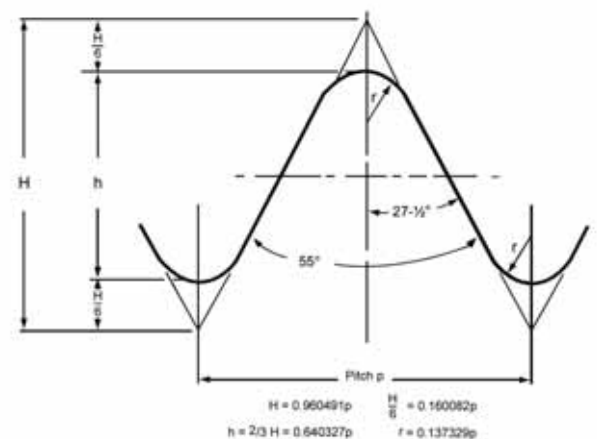

THE WHITWORTH SCREW THREAD TOLERANCE SYSTEM

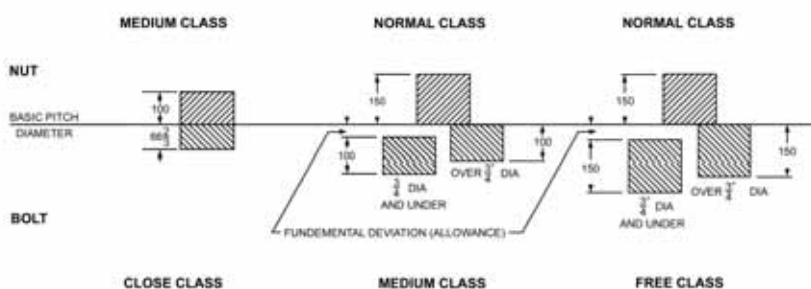

Pitch diameter tolerance zones of recommendations combinations of classes of bolts and nuts having Whitworth screw threads.

Thread Systems

The ISO Standard is the International Standard intended to be adopted throughout the World. The ISO standard covers three groups of threads:-

- ISO – Metric which is a complete thread system in Metric Units
- ISO – Unified screw thread systems
- ISO – British Standard Pipe thread systems

The Whitworth and BA screw thread systems are officially obsolete. However, they are still widely used throughout the world and **GOLIATH** offer a full range of Taps and Dies within these standards.

All measurements must have a controlling point or base from which to start. In case of a screw thread, this control point is called the BASIC or theoretically correct size, which is calculated on the basis of a full form thread. Thus, on a given screw thread, we have Basic Major Diameter, the Basic Pitch Diameter and Basic Minor Diameter.

The Basic Profile is the profile to which the deviations, which define the limits of the external and internal threads, are applied. While it is impossible in practice to form screw threads to their precise theoretical or BASIC sizes, it is possible and practical to establish limits which the deviation must not exceed. These are called the “Maximum” and “Minimum” Limits. If the product is no smaller than the “Minimum Limit” and no larger than the “Maximum Limit”, then it is within the size limits required. This difference between the Maximum and Minimum Limit is the TOLERANCE.

In actual practice the Basic size is not necessarily between Maximum and Minimum Limits. In most cases, the Basic Size is one of the Limits. In general, tolerances for internal threads will be above Basic and for external threads, below Basic.

Tolerance Classes of Metric Taps

Three tolerance classes (termed Class 1, Class 2 and Class 3) are used for the designation of the taps for the production of nuts of the following classes:

- 4H, 5H, 6H, 7H, 8H with zero minimum clearance
- 4G, 5G, 6G with positive minimum clearance

The tolerances for these three classes are determined in BS 949, in terms of tolerance unit t .

The Difference in the Classes

Taps of the different classes vary in the limits of the size of the tap pitch diameter. The tolerance on the tap pitch diameter Td_2 is the same for all three classes of tap (it is equal to 20% of t), but the position of the tolerance zone with respect to the basic pitch diameter depends on the lower deviation.

- Lower Deviation for tap Class 1, $+0.1 t$
- Lower Deviation for tap Class 2, $+0.3 t$
- Lower Deviation for tap Class 3, $+0.5 t$

Choice of Tap Tolerance Class

Unless otherwise specified, taps of classes 1, 2 and 3 are used for the manufacture of nuts in the following classes:

- **Class 1:** for nuts of classes 4H and 5H
- **Class 2:** for nuts of classes 6H and also 4G and 5G
- **Class 3:** for nuts of classes 7H and 8H and also 6G

However, this correspondence is only of a general nature, since the accuracy of tapping varies with a number of factors such as the material being tapped, the condition of the machine tool, the tapping attachment, the tapping speed and the lubricant used.

Users are therefore recommended to select in each case, from previous experience or from special purpose tests, the most suitable class of tap for the manufacture of any required class of nut.

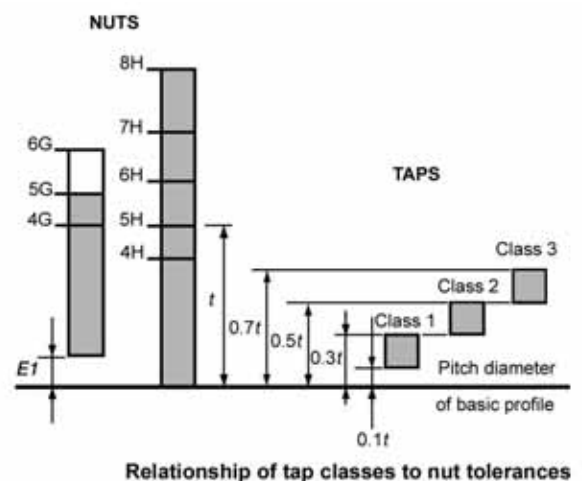

Class & Tolerance Tables (TAPS)

B.S.W.

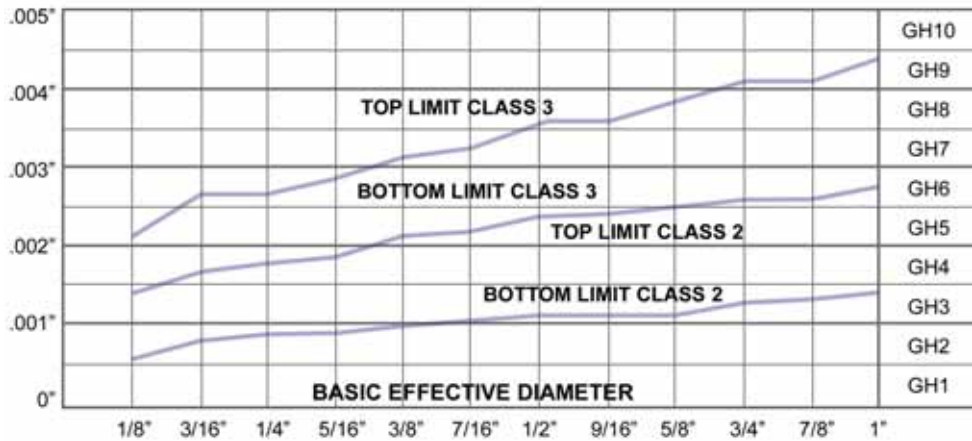

B.S.F.

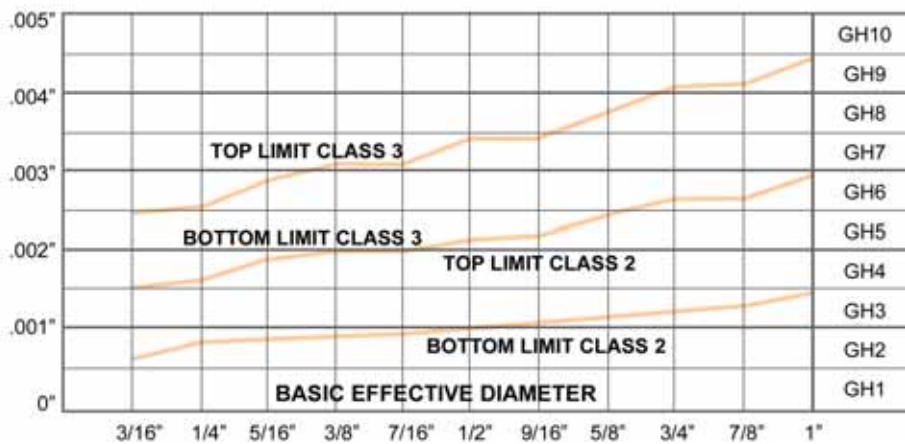

METRIC (I.S.O.)



Class & Tolerance Tables (TAPS)

U.N.F.



U.N.C.

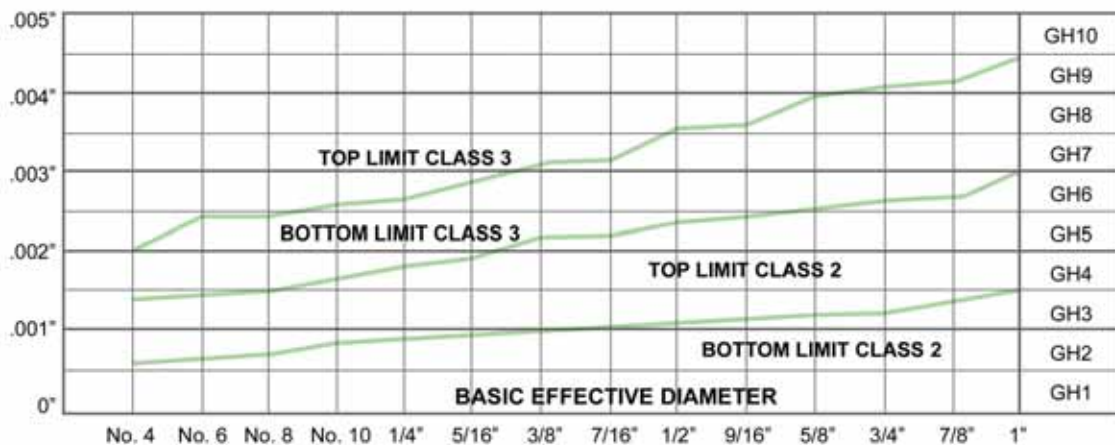

Common Thread Forms

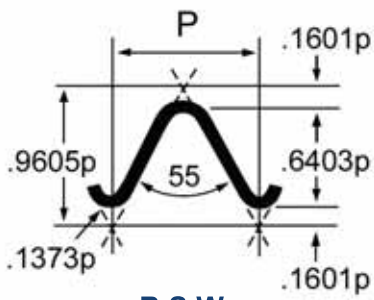

B.S.W.

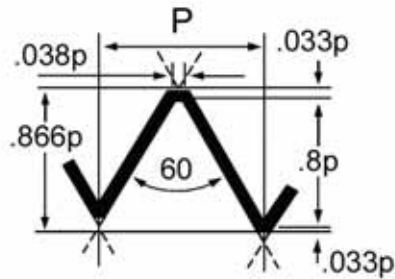

U.S. PIPE TAPER

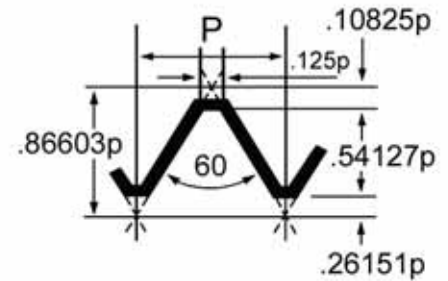

I.S.O. UNIFIED

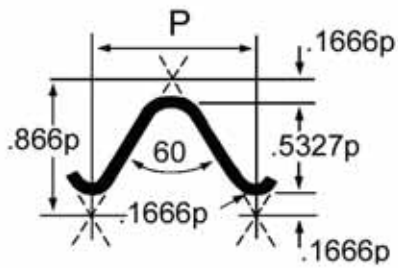

B.S. CYCLE

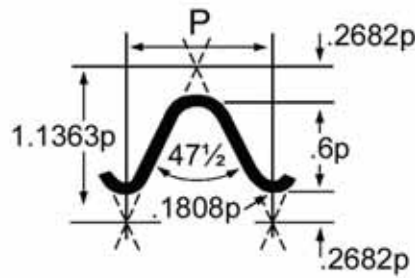

B.A.

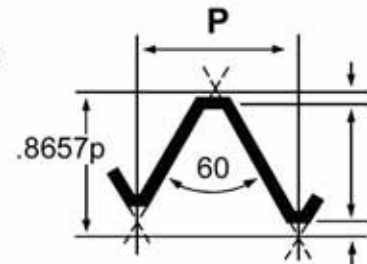

U.S. DRYSEAL N.P.T.F.

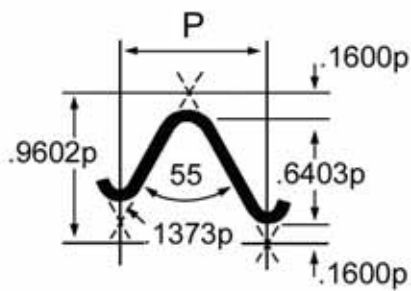

B.S.P.T. (I.S.O. TAPER PIPE)

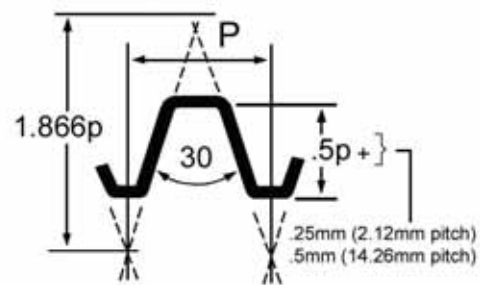

TRAPEZOIDAL

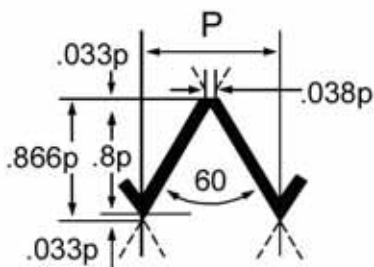

U.S. PIPE STRAIGHT

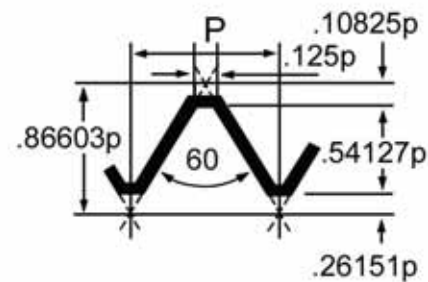

I.S.O. METRIC

Cutting Speeds and Lubricants

MATERIAL	CUTTING SPEED ft. per min.		LUBRICANT OR COOLANT
	C.S.	H.S.S.	
Aluminium	30-50	70-90	Soluable oil. Paraffin + Lard Oil
Aluminium Alloys	20-30	50-70	Soluable oil. Paraffin + Lard Oil
Brass (free cutting)	40-50	80-100	Soluable oil. Paraffin + Lard Oil
Brass (wrought)	25-35	60-80	Soluable oil. Paraffin + Lard Oil
Bronze (phosphor)		30-40	Soluable oil. Paraffin + Lard Oil
Bronze (tin)		40-60	Soluable oil. Paraffin + Lard Oil
Bronze (high tensile)		25-35	Soluable oil. Paraffin + Lard Oil
Copper	25-35	60-80	Soluable oil. Paraffin + Lard Oil
Gun Metal		50-60	Soluable oil. Paraffin + Lard Oil
Iron (grey cast)	15-25	30-60	Soluable oil. Air Blast
Iron (malleable)		20-40	Soluable oil. Air Blast
Iron (alloy cast)		15-30	Sulphurized oil
Magnesium alloys	25-35	50-70	Soluable oil. Paraffin + Lard Oil
Nimonic alloys		8-12	Extreme Pressure cutting oils
Zinc Base alloys	25-35	50-70	Paraffin
Bakelite and Plastics	25-35	50-70	Air Blast
Steel (mild)	15-25	30-50	Soluable oil. Sulphurized oil
Steel (up to 0.4% carbon)		20-40	Soluable oil. Sulphurized oil
Steel (up to 0.7% carbon)		20-30	Soluable oil. Sulphurized oil
Steel (over 0.7% carbon)		15-25	Soluable oil. Sulphurized oil
Steel alloy (up to 60 T tensile)		15-25	Soluable oil. Sulphurized oil
Steel alloy 60-80 T tensile)		10-15	Soluable oil. Sulphurized oil
Steel (stainless magnetic)		10-20	Sulphurized oil
Steel (stainless non-magnetic)		10-15	Sulphurized oil
Steel (Tool)		15-25	Sulphurized oil

Use slowest speed first, increase if work and conditions permit.

Taper thread taps (B.S.P., Tr., N.P.T. etc.) should run at approximately 50% - 60% of normal speed.

Taps with very coarse pitches such as Square or Acme should be run at 40% - 50% of normal speed.

Faults and Causes

CAUSE	FAULT	FAULT	FAULT	FAULT	FAULT	FAULT
	OVERSIZED HOLES BELLMOUTH HOLES	POOR THREAD FINISH	CHIPPING OF TAP TEETH	EXCESSIVE TAP WEAR	TAP BREAKAGE	COLD-WELDING
MISALIGNMENT						
LEAD REGROUND ECCENTRIC						
INCORRECT FEED						
INCORRECT TAP						
INCORRECT SHARPENING						
INCORRECT LUBRICANT						
TAP BOTTOMING						
SPEED TOO HIGH						
HOLE WORK HARDENED						
FAULTY MACHINE						
INSUFFICIENT CHIP REMOVAL						
INCORRECT TAP DRILL						
BLUNT TAP						
MATERIAL TOO SOFT						

Correct tapping drill size is important in relation to the torque. For example, when thread percentage is increased from 60% to 80% the torque can be trebled.

The use of incorrect lubricant can in some instances almost double the torque.

Where possible use standard taps which are available from stock and are cheaper than specials.

These factors should be considered regarding wear and economy in the use of taps.

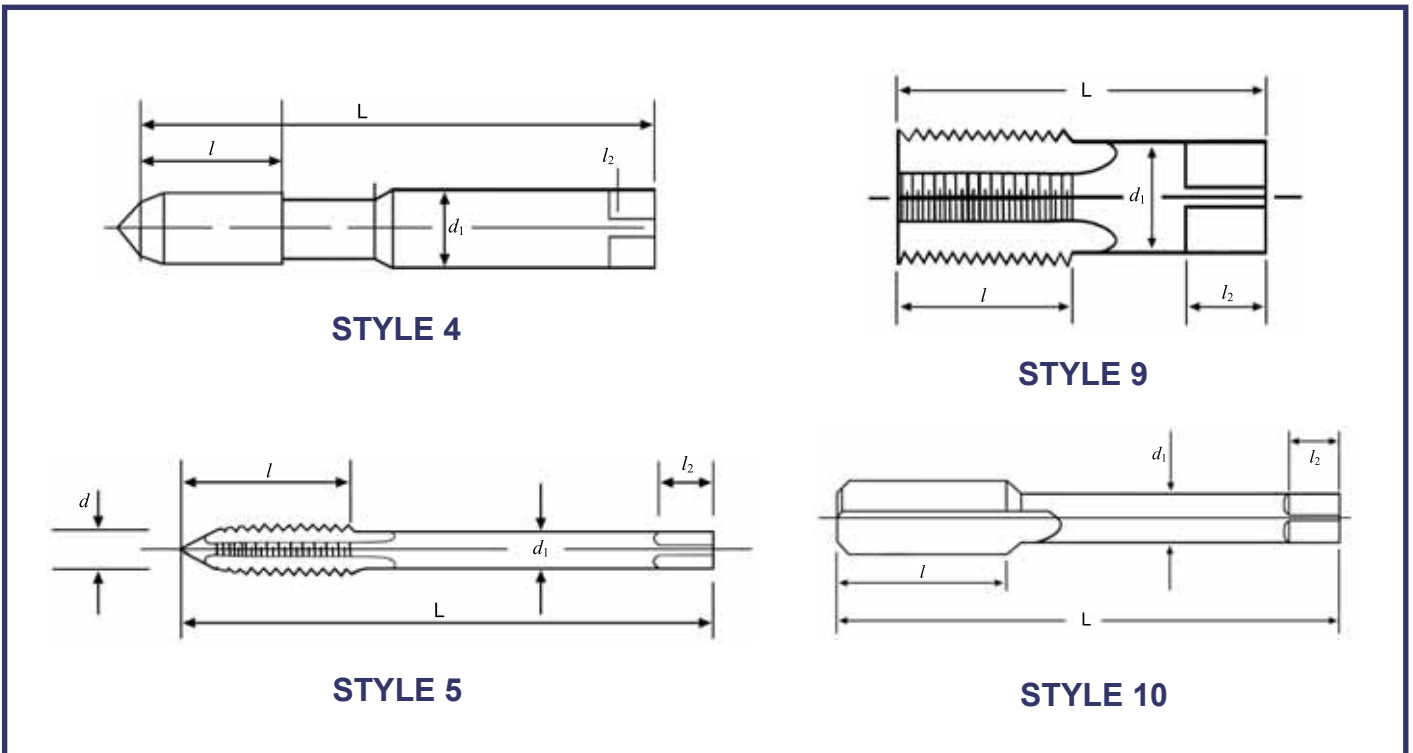
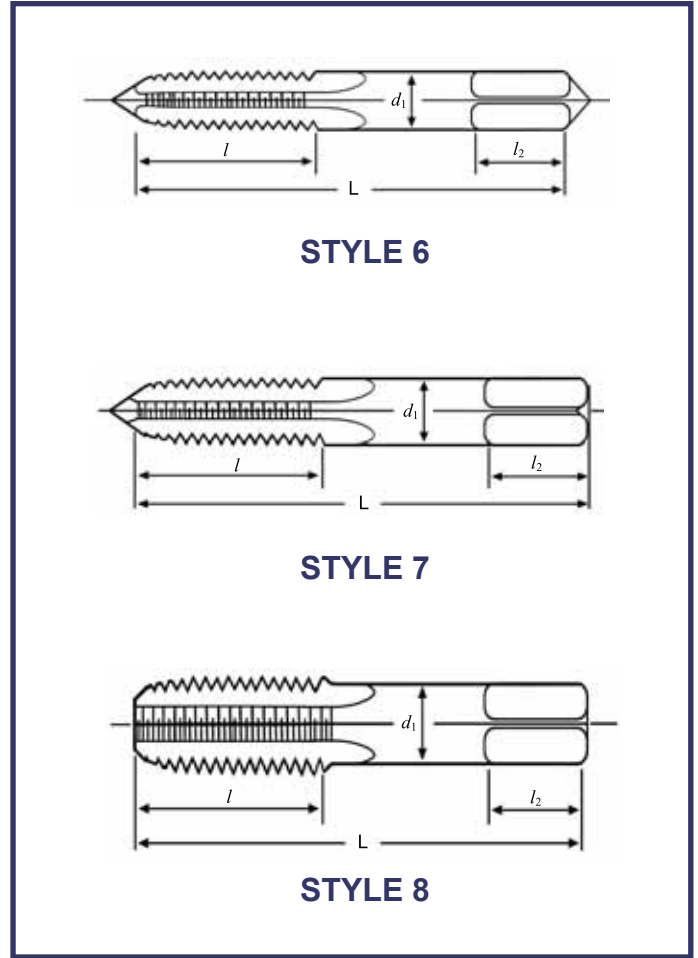
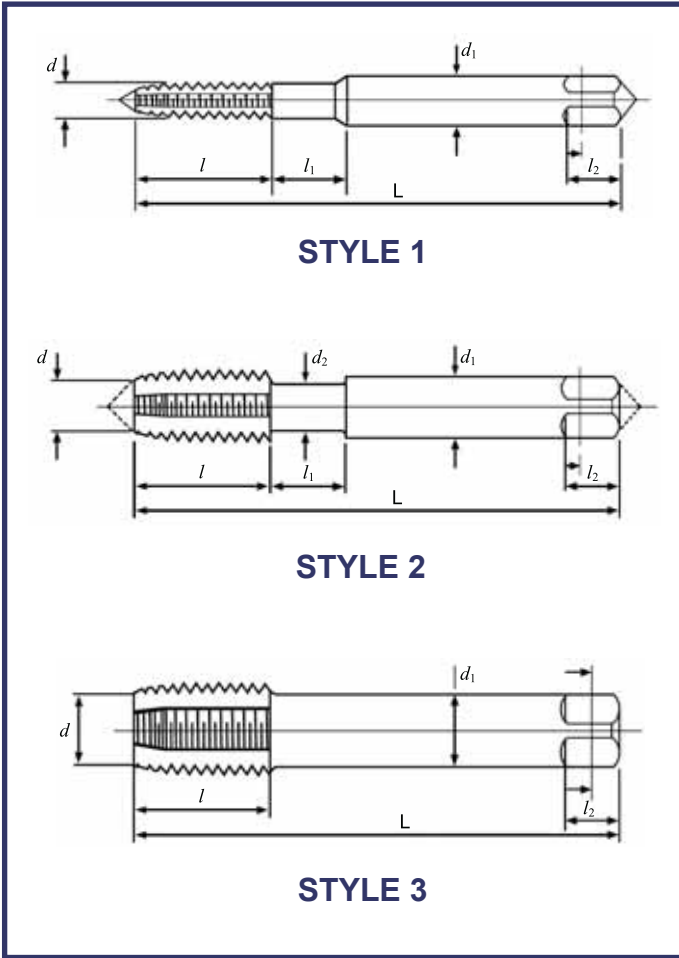

Tapping Drill Chart

METRIC (I.S.O.) FINE		
Nominal Dia. of Threads mm.	Pitch [p] mm.	Tapping Drill Dia. mm.
M2.0	0.25	1.75
M2.2	0.25	1.95
M2.5	0.35	2.15
M3.0	0.35	2.65
M3.5	0.35	3.15
M4.0	0.50	3.50
M4.5	0.50	4.00
M5.0	0.50	4.50
M6.0	0.75	5.20
M7.0	0.75	6.20
M8.0	0.75	7.20
M8.0	1.00	7.00
M9.0	0.75	8.20
M9.0	1.00	8.00
*M10.0	1.00	9.00
M10.0	1.25	8.80
M11.0	1.00	10.00
M12.0	1.00	11.00
*M12.0	1.25	10.80
M12.0	1.50	10.50
M14.0	1.00	13.00
*M14.0	1.25	12.80
M14.0	1.50	12.50
M16.0	1.00	15.00
M16.0	1.50	14.50
M18.0	1.00	17.00
*M18.0	1.50	16.50
M18.0	2.00	16.00
M20.0	1.00	19.00
M20.0	1.50	18.50
M20.0	2.00	18.00
M22.0	1.00	21.00
M22.0	1.50	20.50
M22.0	2.00	20.00
M24.0	1.00	23.00
M24.0	1.50	22.50
M24.0	2.00	22.00
M25.0	1.50	23.50
M25.0	2.00	23.00
M27.0	1.50	25.50
M28.0	1.50	26.50
M30.0	1.50	28.50
M32.0	1.50	30.50
M33.0	2.00	31.00
M36.0	3.00	33.00
M39.0	3.00	36.00
M40.0	1.50	38.50
M40.0	3.00	37.00
M42.0	4.00	38.00
M45.0	4.00	41.00
M48.0	4.00	44.00
M52.0	4.00	48.00
M56.0	4.00	52.00
M60.0	4.00	56.00

METRIC (I.S.O.) COARSE		
Nominal Dia. of Threads mm.	Pitch [p] mm.	Tapping Drill Dia. mm.
M2.0	0.40	1.60
M2.2	0.45	1.75
M2.5	0.45	2.05
M3.0	0.50	2.50
M3.5	0.60	2.90
M4.0	0.70	3.30
M4.5	0.75	3.70
M5.0	0.80	4.20
M6.0	1.00	5.00
M7.0	1.00	6.00
M8.0	1.25	6.80
M9.0	1.25	7.80
M10.0	1.50	8.50
M11.0	1.50	9.50
M12.0	1.75	10.20
M14.0	2.00	12.00
M16.0	2.00	14.00
M18.0	2.50	15.50
M20.0	2.50	17.50
M22.0	2.50	19.50
M24.0	3.00	21.00
M27.0	3.00	24.00
M30.0	3.50	26.50
M33.0	3.50	29.50
M36.0	4.00	32.00
M39.0	4.00	35.00
M42.0	4.50	37.50
M45.0	4.50	40.50
M48.0	5.00	43.00
M52.0	5.00	47.00
M56.0	5.50	50.50
M60.0	5.50	54.50

Fluteless	
Tap	Drill Size mm.
ISO Metric Course	
M3	2.8
M3.5	3.2
M4	3.7
M5	4.6
M6	5.6
M8	7.4
M10	9.3
M12	11.1
UNC (NC)	
No 2	1.95
No 4	2.55
No 6	3.2
No 8	3.8
No 10	4.3
1/4	5.8
5/16	7.3
3/8	8.8
1/2	11.7
B.A.	
2BA	4.4
4BA	3.3
6BA	2.6
8BA	2.0
UNF (NF)	
No 4	2.6
No 6	3.2
No 8	3.9
No 10	4.5
1/4	5.9
5/16	7.5
3/8	9.0
1/2	12.1
BSF	
1/4	5.8
5/16	7.3
3/8	8.9
BSW	
1/8	2.9
3/16	4.2
1/4	5.7
5/16	7.2
3/8	8.7

Unified National Fine (U.N.F.)		
Nominal Dia. of Threads	Pitch [p] mm. T.P.I.	Tapping Drill Dia. mm.
No. 0	0.318 80	1.25
No. 1	0.353 72	1.55
No. 2	0.397 64	1.90
No. 3	0.454 56	2.15
No. 4	0.529 48	2.40
No. 5	0.577 44	2.70
No. 6	0.635 40	2.95
No. 8	0.706 36	3.50
No. 10	0.794 32	4.10
No. 12	0.907 28	4.70
1/4"	0.907 28	5.50
5/16"	1.058 24	6.90
3/8"	1.058 24	8.50
7/16"	1.270 20	9.90
1/2"	1.270 20	11.50
9/16"	1.411 18	12.90
5/8"	1.411 18	14.50
3/4"	1.588 16	17.50
7/8"	1.814 14	20.40
1"	2.117 12	23.25
1.1/8"	2.117 12	26.50
1.1/4"	2.117 12	29.50
1.3/8"	2.117 12	32.75
1.1/2"	2.117 12	36.00

Unified National Coarse (U.N.C.)		
Nominal Dia. of Threads	Pitch (p) mm. T.P.I.	Tapping Drill Dia. mm.
No. 1	0.397 64	1.55
No. 2	0.454 56	1.85
No. 3	0.529 48	2.10
No. 4	0.635 40	2.35
No. 5	0.635 40	2.65
No. 6	0.794 32	2.85
No. 8	0.794 32	3.50
No. 10	1.058 24	3.90
No. 12	1.058 24	4.50
1/4"	1.270 20	5.10
5/16"	1.411 18	6.60
3/8"	1.588 16	8.00
7/16"	1.814 14	9.40
1/2"	1.954 13	10.80
9/16"	2.117 12	12.20
5/8"	2.309 11	13.50
3/4"	2.540 10	16.50
7/8"	2.822 9	19.50
1"	3.175 8	22.25
1.1/8"	3.629 7	25.00
1.1/4"	3.629 7	28.00
1.3/8"	4.233 6	30.75
1.1/2"	4.233 6	34.00
1.3/4"	5.080 5	39.50
2"	5.644 4.5	45.00

BRITISH ASSOCIATION (B.A.)		
Nominal Dia. of Threads	Pitch [p] mm. T.P.I.	Tapping Drill Dia. mm.
No.0	1.00	5.10
No.1	0.90	4.50
No.2	0.81	4.00
No.3	0.73	3.40
No.4	0.66	3.00
No.5	0.59	2.65
No.6	0.53	2.30
No.7	0.48	2.05
No.8	0.43	1.80
No.9	0.39	1.55
No.10	0.35	1.40
No.11	0.31	1.20
No.12	0.28	1.05
No.13	0.25	0.98
No.14	0.23	0.80

NATIONAL STANDARD PIPE (N.P.T.)		
Nominal Dia. of Threads	Pitch (p) mm. T.P.I.	Tapping Drill Dia. mm.
1/16"	0.940 27	6.30
1/8"	0.940 27	8.70
1/4"	1.411 18	11.10
3/8"	1.411 18	14.50
1/2"	1.814 14	18.00
3/4"	1.814 14	23.25
1"	2.208 11.5	29.00
1.1/4"	2.208 11.5	38.00
1.1/2"	2.208 11.5	44.00
2"	2.208 11.5	56.00
2.1/2"	3.175 8	67.00

BRITISH STANDARD WHITWORTH (B.S.W.)		
Nominal Dia. of Threads	Pitch [p] mm. T.P.I.	Tapping Drill Dia. mm.
1/8"	0.0250 40	2.55
3/16"	0.0417 24	3.70
1/4"	0.0500 20	5.10
5/16"	0.0556 18	6.50
3/8"	0.0625 16	7.90
7/16"	0.0714 14	9.30
1/2"	0.0833 12	10.50
9/16"	0.0833 12	12.10
5/8"	0.0909 11	13.50
11/16"	0.0909 11	15.00
3/4"	0.1000 10	16.25
7/8"	0.1111 9	19.25
1"	0.1250 8	22.00
1.1/8"	0.1429 7	24.75
1.1/4"	0.1429 7	28.00
1.1/2"	0.1667 6	33.50
1.3/4"	0.2000 5	39.00
2"	0.2222 4.5	44.50

BRITISH STANDARD FINE (B.F.)		
Nominal Dia. of Threads	Pitch [p] mm. T.P.I.	Tapping Drill Dia. mm.
3/16"	0.0312 32	4.00
7/32"	0.0357 28	4.60
1/4"	0.0385 26	5.30
9/32"	0.0385 26	6.10
5/16"	0.0455 22	6.80
3/8"	0.0500 20	8.30
7/16"	0.0556 18	9.70
1/2"	0.0625 16	11.10
9/16"	0.0625 16	12.70
5/8"	0.0714 14	14.00
11/16"	0.0714 14	15.50
3/4"	0.0833 12	16.75
7/8"	0.0909 11	19.75
1"	0.1000 10	22.75
1.1/8"	0.1111 9	25.50
1.1/4"	0.1111 9	28.25
1.3/8"	0.1250 8	31.50
1.1/2"	0.1250 8	34.50

BRITISH STANDARD PIPE FASTENING (B.S.P.F.) G		
Nominal Dia. of Threads	Pitch (p) mm. T.P.I.	Tapping Drill Dia. mm.
1/8"	0.907 28	8.80
1/4"	1.337 19	11.80
3/8"	1.337 19	15.25
1/2"	1.814 14	19.00
5/8"	1.814 14	21.00
3/4"	1.814 14	24.50
7/8"	1.814 14	28.25
1"	2.309 11	30.75
1.1/4"	2.309 11	39.50
1.1/2"	2.309 11	45.00
1.3/4"	2.309 11	51.00
2"	2.309 11	57.00

BRITISH STANDARD PIPE THREAD RC SERIES (B.S.P.T.)		
Nominal Dia. of Threads	Pitch (p) mm. T.P.I.	Tapping Drill Dia. mm.
1/8"	0.907 28	8.40
1/4"	1.337 19	11.20
3/8"	1.337 19	14.75
1/2"	1.814 14	18.25
3/4"	1.814 14	23.75
1"	2.309 11	30.00
1.1/4"	2.309 11	38.50
1.1/2"	2.309 11	44.50
2"	2.309 11	58.00
2.1/2"	2.309 11	71.00

BRITISH STANDARD PIPE PARALLEL (B.S.P.PI) Rp		
Nominal Dia. of Threads	Pitch (p) mm. T.P.I.	Tapping Drill Dia. mm.
1/8"	0.907 28	8.60
1/4"	1.337 19	11.50
3/8"	1.337 19	15.00
1/2"	1.814 14	18.75
3/4"	1.814 14	24.25
1"	2.309 11	30.40
1.1/4"	2.309 11	39.00
1.1/2"	2.309 11	45.00
2"	2.309 11	56.75





Head Office UK

Goliath International Tools Ltd

Goliath House, Newtown Row, Aston,
Birmingham B6 4NQ.

UK Call Centre

Telephone: +44 0121 333 3441
Fax: +44 0121 359 6647
E-mail: sales@goliathinternational.com

Export

Telephone: +44 0121 359 6621
Fax: +44 0121 359 7092

Australia

Goliath Threading Tools Ltd

336 Victoria Street
Brunswick
Victoria 3056,
Australia

Telephone: 00 6139 3874755
Fax: 00 6139 3879219

Canada

Goliath Threading Tools Ltd Canada Ltd

Unit L
240 Holiday Inn Drive
Cambridge
Ontario
Canada

Telephone: 001-519-651-1510
Fax: 001-519-651-1513

Ireland

Goliath Threading Tools (Ireland) Ltd

67 Main Street
Blackrock
Co. Dublin
Ireland

Telephone: 00 3531 2887341
Fax: 00 3531 2886992

South Africa

Goliath Threading Tools S.A. Pty Ltd

Unit 7 Zero Park
365 Fabriek St
Strijdompark Ext 21
Randburg, South Africa

Telephone: 00 2711 792 5659
Fax: 00 2711 792 5374

U.S.A.

Goliath Threading Tools Inc

9092 Telegraph Road
Detroit
Michigan 48239
USA

Telephone: 001-313-538-2460/0999
Fax: 001-313-538-8099

Your Local Goliath Approved Distributor: